

PK2

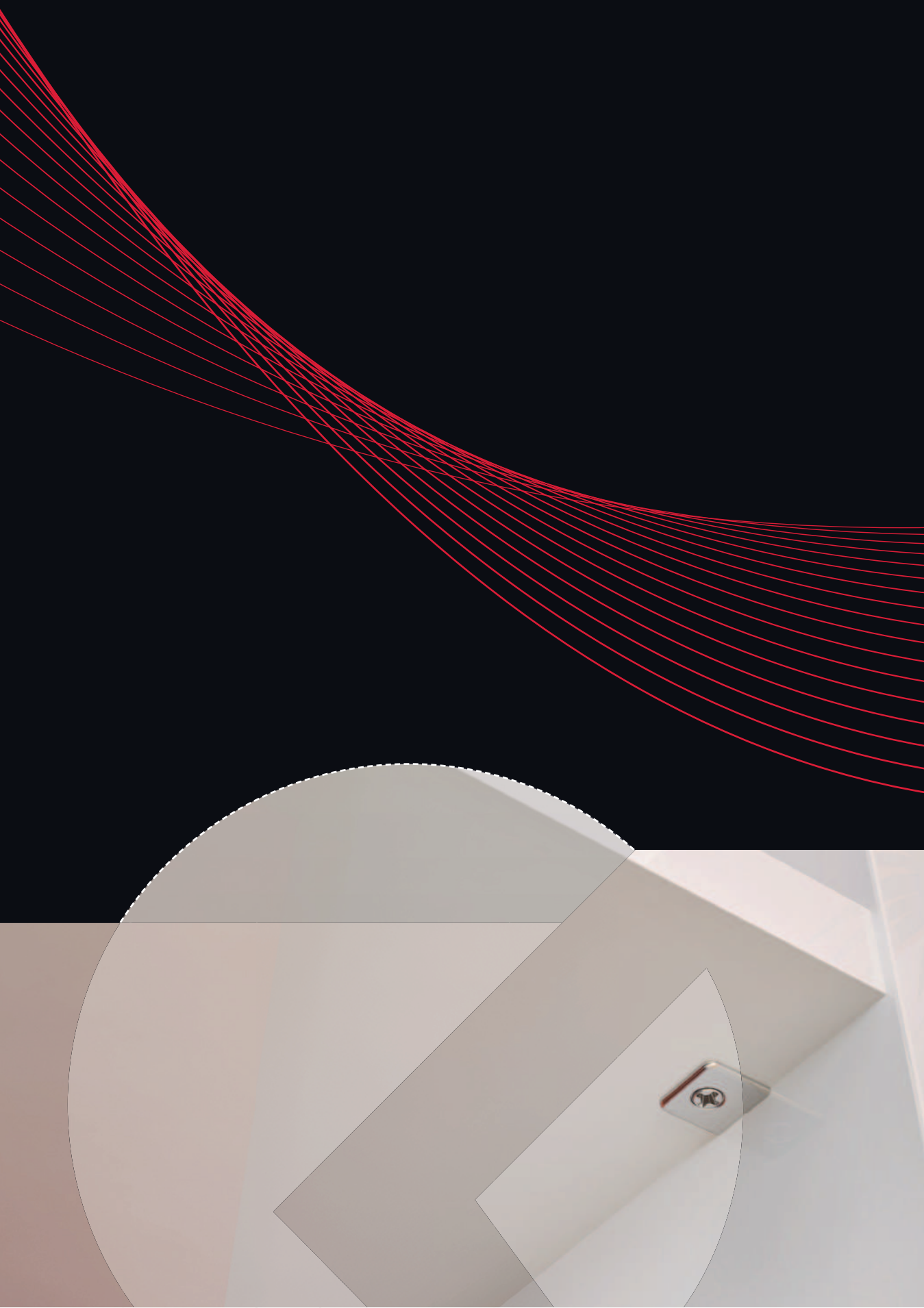

SHELF
SUPPORTS





PK2

PK2 is the new concept in wood shelf supports, to be slotted into the panel by making face borings.

It allows to join together any side and shelf, including bottom and top, without using any further connecting fitting. The panel has to be pushed downwards onto the side brackets, which can be screwed into any position required. The side bracket slots into the socket of the shelf supports and a click locks the panel in position.

To provide the furniture with structural fastening, the version with mini fix within the plastic shelf support is required. By turning the mini fix placed inside the shelf support 90° anticlockwise from the bottom, the shelf and top panel collide with the sides, providing a structural fastening.

An optional through hole Ø 8mm allows you to fix also the bottom panel from the top by turning the mini fix 90° anticlockwise.



16 mm min.

UNI EN 14749/05 and UNI 8603/05

INSTALLATION AND ASSEMBLING

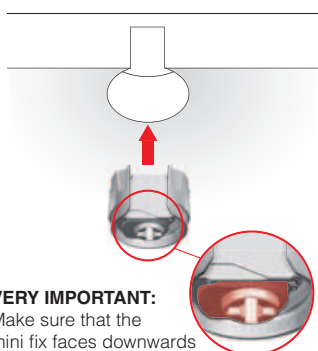

VERY IMPORTANT:
Make sure that the mini fix faces downwards

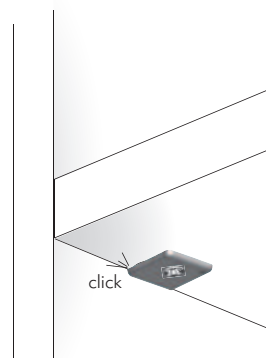
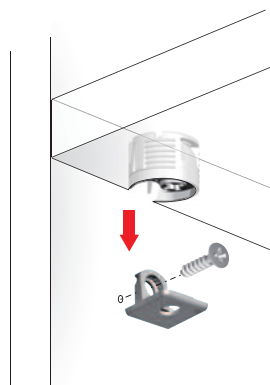

STRUCTURAL FASTENING WITH CROSS PZ2 SCREWDRIVER:

90° turning from the upper side, for the furniture floor.

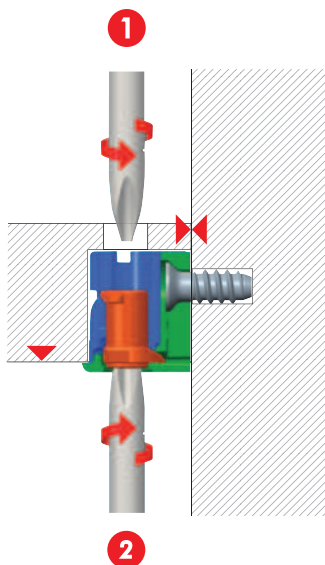

90° turning from the lower side, for the shelves and for the top.

Assembling with alternative spreading bush and screw to avoid hole damaging for shelf repositioning.

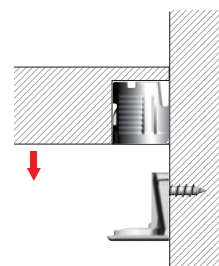

Assembling with pre-inserted spreading bush and screw to avoid hole damaging for shelf repositioning.

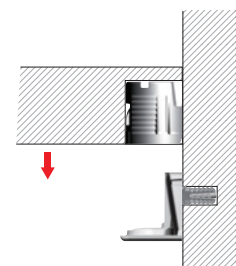

LOCKING DETAIL:

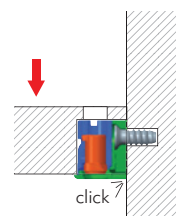

After turning the minifix.

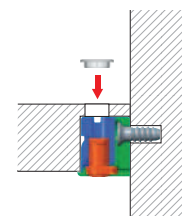

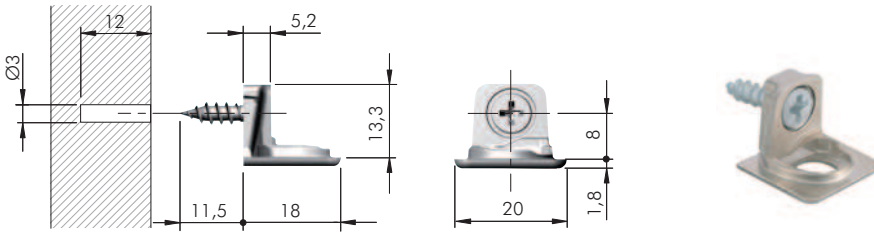

= Ø 3 mm +

= PZ2

= 2500 pcs.

11402050YA

DRILL BIT FOR PK2 **16 mm**

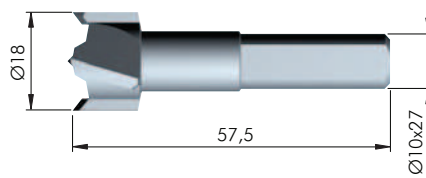
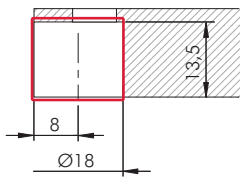

= on request

1145201000

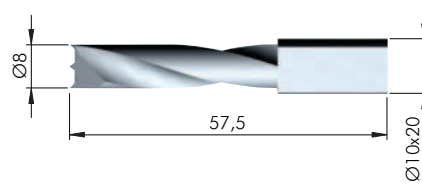
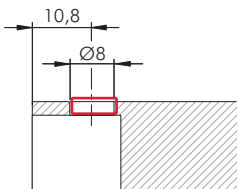

= on request

1145202000

PK2 **18 - 19 mm**

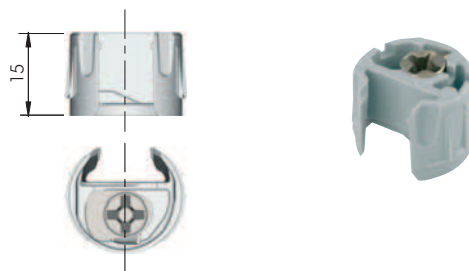
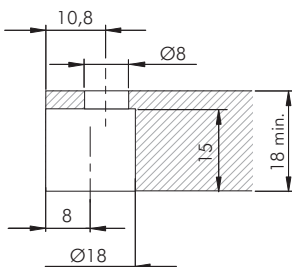

= PZ2

= 2500 pcs.

11401030IJ

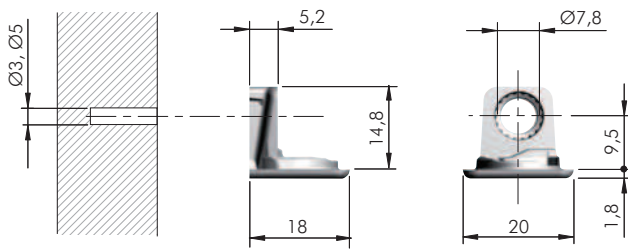

= Ø 3, Ø 5 mm +
 ZA = 2500 pcs.
 |
 11403010YA

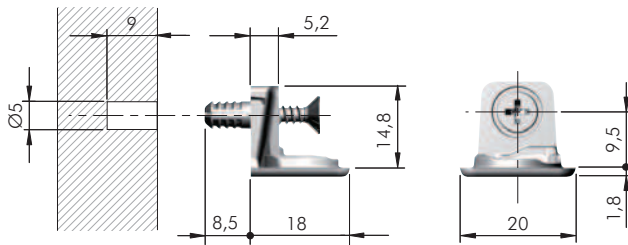

= Ø 5 mm +
 = PZ2
 ZA ST EP = 2500 pcs.
 |
 11403020YA

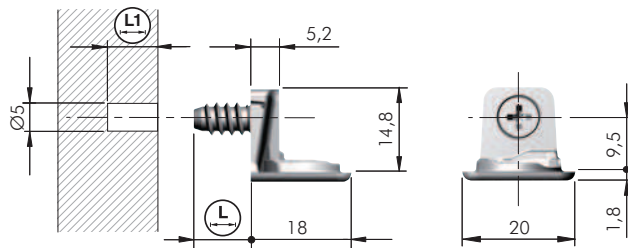

= Ø 5 mm +
 = PZ2
 ZA ST = 2500 pcs.
 | |
 11403100YA 8,5 | 9
 11403030YA 10 | 10,5

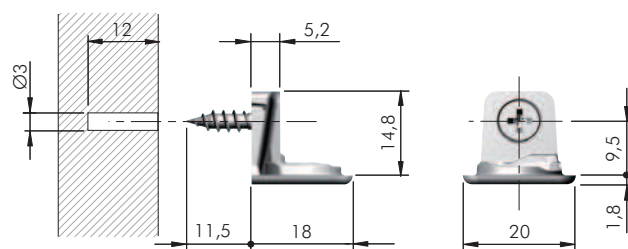

= Ø 3 mm +
 = PZ2
 ZA ST = 2500 pcs.
 |
 11403050YA



PK2 ACCESSORY

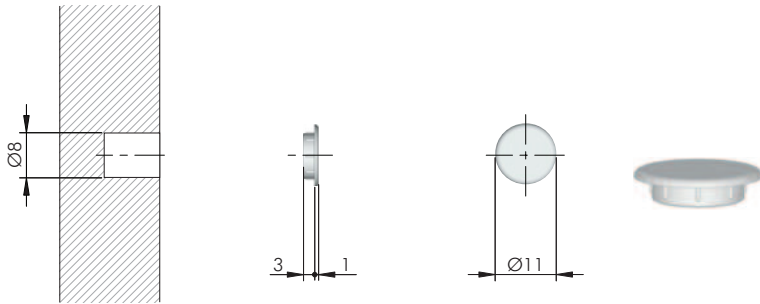

= Ø 8 mm +
 = 5000 pcs.
23002010**AB**

PK2 FIXING ACCESSORIES

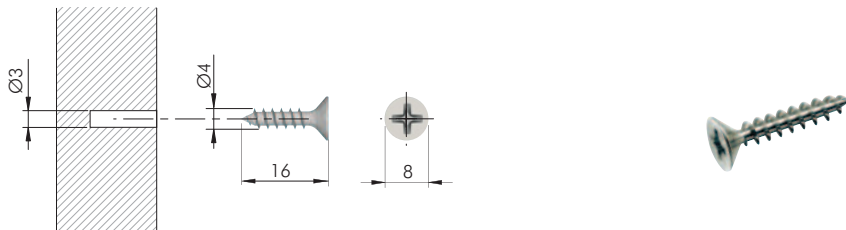

= Ø 3 mm
 = PZ2
 = 5000 pcs.
60101570**ZN**

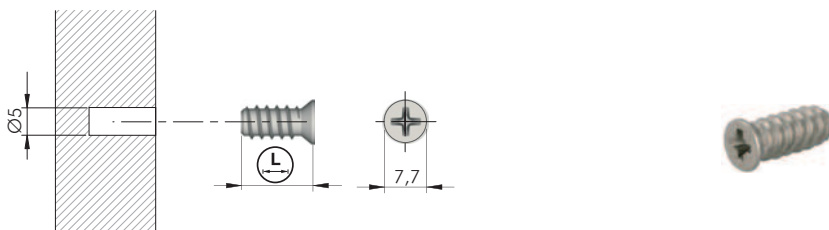

= Ø 5 mm +
 = PZ2

60502010 ZN	10	9000
60501050 YA	12,7	5000
60502020 ZN	13	5000
60502030 ZN	15	5000



SHELF
SUPPORTS

PK2

ITALIANA[®]
ferramenta

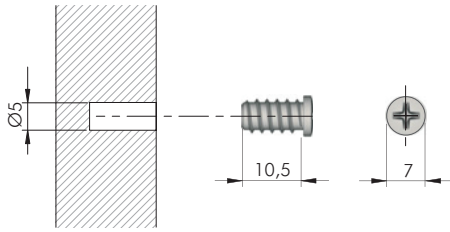

= Ø 5 mm +

= PZ2

ST = 5000 pcs.

60507010YA

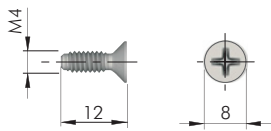

= M4 = PZ2

ST = 2000 pcs.

60305040ZN

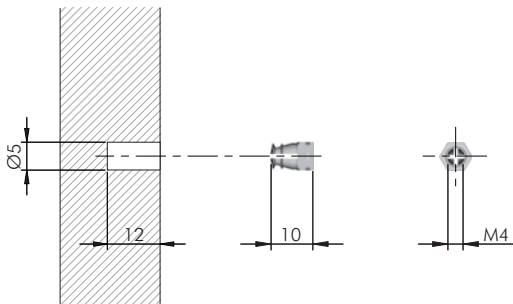

= Ø 5 mm = M4

BR = 20.000 pcs.

20502021HL