

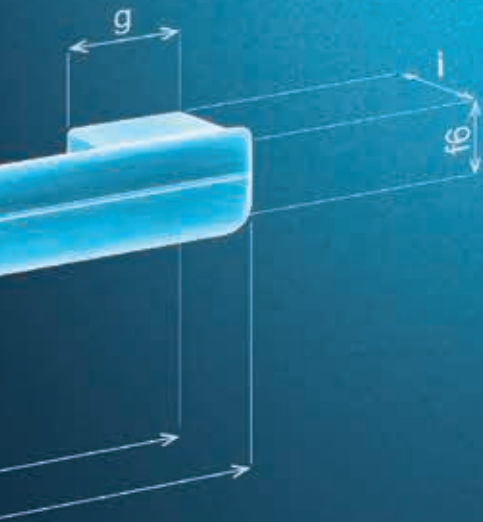

fogantyúk, fogantyúprofilok, fogasok



ÖNÁLLÓ KATALÓGUS

A beltéri fogantyúk mintáival ellátott teljes áttekintésért lásd a Tulip fogantyúk külön dizájn-katalógusát. Használja bátran, amikor az ügyféllel együtt választ.



3D MODELLEK BÚTORTERVEZÉSI SZOFTVEREKHEZ

Minden fogantyút 3D-ben is előkészítettünk a tervezőprogramok számára. Letölthetőek a demos24plus.com portálunkról.



BEMUTATÓ VASALATOK A PARTNEREINKNÉL

A fogantyúk kiválasztásának legjobb módja, ha élőben választunk. Látogassa meg viszonteladó partnereinket, és tapasztalja meg az érinthető minőséget.



PORTÁL24PLUS

A portál vásárlásra, megrendelések áttekintésére, rendelések leadására, formázására, és állapotuk ellenőrzésére szolgál, valamint raktárkészlet és a megszabott árakra vonatkozó információk mellett még sok minden másról is értesülhetünk egy helyen.



TANÁCSADÁS

Tanácsstalan a vasalatok és a szerelés kiválasztásával kapcsolatban? Hívja ügyfélszolgálatunkat a +36 1 445 3730 telefonszámon, vagy írjon a megrendelesek@demos-trade.com címre, és örömmel adunk Önnek tanácsot.



HÁZHOZSZÁLLÍTÁS

Minden megrendelést akár kettő munkanapon belül kézbesítünk Önnek.

01



02



03



04



05



06



07



08



09



10



11



12



13



14



tartalom

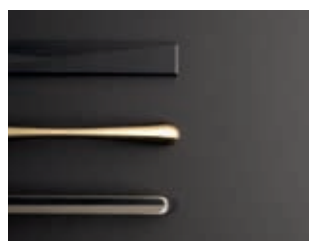
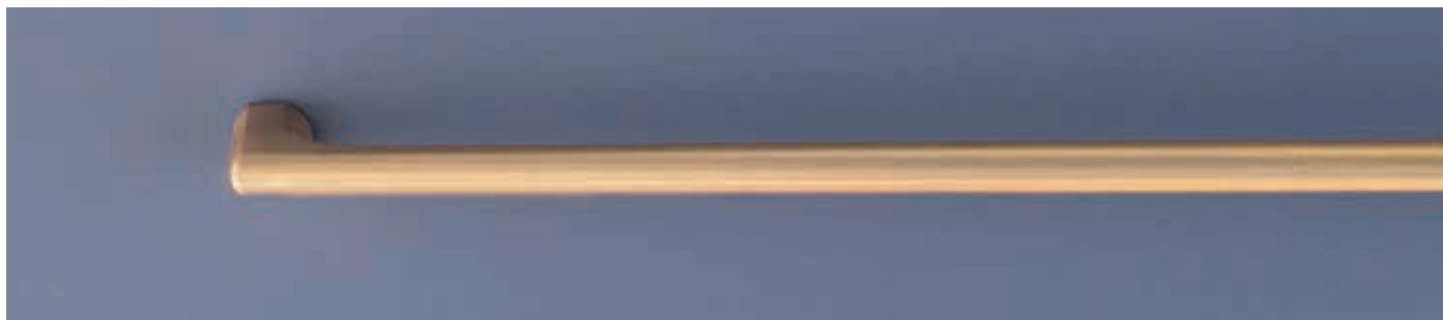

fém fogantyúk és gombok

Tulip	11.15
Marella	11.77
Hettich	11.85

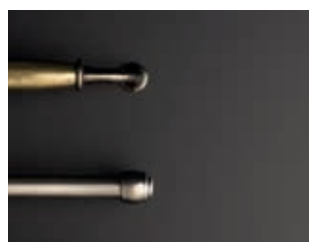

rusztikus és porcelán

Tulip	11.38
Marella	11.80



süllyesztett fogantyúk és profilok

Tulip	11.45
Hettich	11.89
Marella	11.84

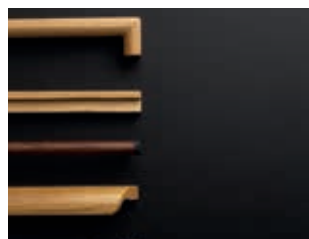

fa és bőr

Tulip	11.61
-------	-------

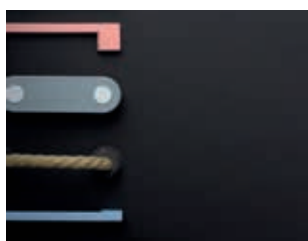
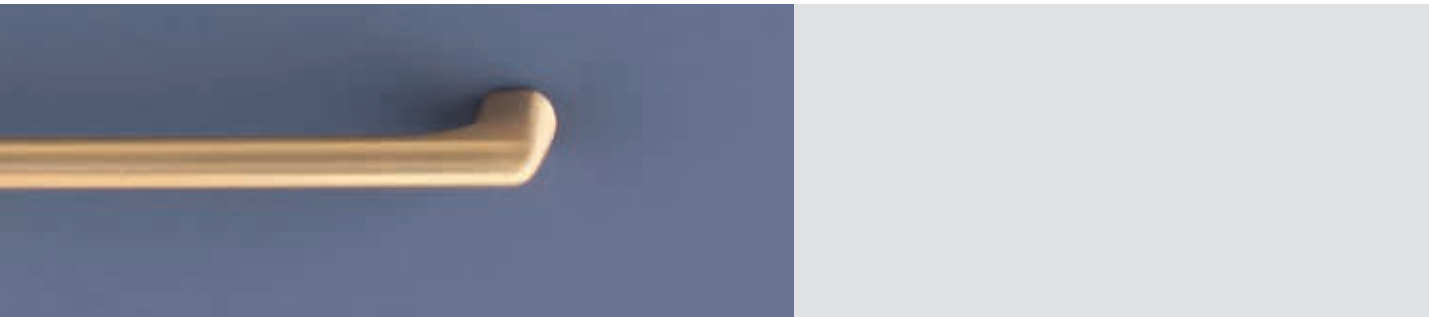

gyermek
és műanyag

Tulip

11.66

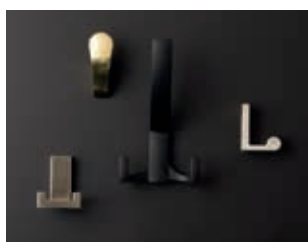

fogasok

Tulip

11.69



fogantyúk,
bútorgombok és
fogasok

Marella
Hettich

11.77
11.85

Anyag rövidítések:

[Zn]	[Alu]	[Fe]	[Zamac]	[Stainless steel]	[PWC]	[L]
cink	alumínium	acél	zamac	rozsdamentes acél	polipropilén farost cellulóz	bőr

színek áttekintése

A fogantyúk és fogasok színeinek áttekintése



króm



nemesacél



nemesacél imitáció



nikkel



sötét nikkel



eloxált alumínium



arany



óarany



bronz



óbronz



réz



óréz



ezüst



cink



! n A fogantyúk különböző felületkezeléssel rendelkeznek: csiszolt, fényes, matt. Az egyes színek és dekorok a beszállítóktól függően különbözőek lehetnek.

ócsink



bőr



antracit



sötét arany



fekete



pezsgőarany



ófekete



coffee



barna



pezsgőbronz



fehér

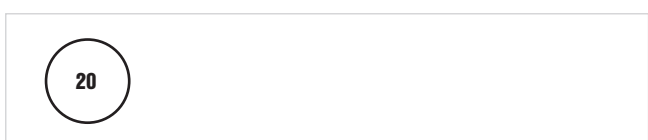

titanium

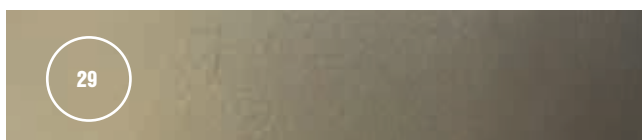

fa



acélszürke

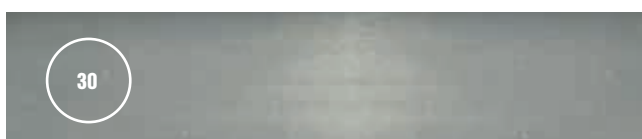

műanyag



beton



porcelán



föld

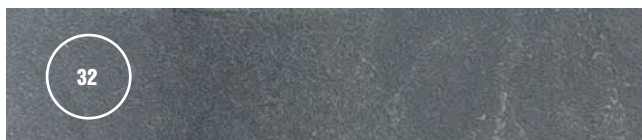

fogantyúk és fogasok áttekintése

Fogantyúk
és fogasok
áttekintése

Tonk 11.15



Scala 11.15



Scoop 11.15



Peblo 11.15



Wake 11.16



Asama 11.16



Umberto 11.16



Marca 11.16



Cub 11.16



Iris 11.17



Oga 11.17



Muta 11.17



Peca 11.17



Recife 11.18



Palm 11.18



Recife II 11.18



Enuca 11.18



Mella 11.18



Boise 11.19



Joliet 11.19



Lenox 11.19



Cory 11.19



Mount 11.19



Resina 11.20



Davide 11.20



Marina 11.20



Penka 11.20



Nakana 11.21



Luca 11.21



Ulica 11.21



Menusa 11.21



Rocata 11.22



Sosa 11.22



Bastone 11.22



Lacata 11.22



Ida 11.23



Kira 11.23



Hrazda 11.24



Porta 11.24



Wakano 11.25



Jakoto 11.25



Likano 11.25



Hytech 11.25



Zuzana 11.25



Napa 11.26



Isola 11.26



Yuma 11.26



Acri 11.26



Envel 11.26



Sulky 11.27



Kentucky 11.27



Kink 11.27



Halti 11.27



Andrea 11.27



Besina 11.27



Nomina 11.28



Ruona 11.28



Piombina 11.28



Iluna 11.28



Beta 11.29



Anita 11.29



Uroso 11.29



Unesa 11.30



Palin 11.30



Vali 11.30



Sema 11.30



Kewina 11.31



Pelena 11.31



Malada 11.31



Sakita 11.31



Geneda 11.31



Fiona 11.31



Ruota 11.32



Kutta 11.32



Ruota 11.32



Enza 11.32



Kutta 11.32



Enza 11.32













Blink 11.33



Tonk 11.33







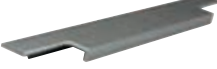

fogantyúk és fogasok áttekintése

	Mesa	11.33		Evan	11.35		Tinto	11.37		Victoria	11.38
	Envel	11.33		Koby	11.35		Kentucky	11.37		Turia	11.39
	Kink	11.33		Marusa	11.35		Peca	11.37		Rustik	11.39
	Bella	11.33		Galka	11.35		Prisma	11.37		Country	11.39
	Conic	11.34		Tomic	11.36		Frame	11.37		Turia	11.39
	Mella	11.34		Boise T	11.36	Rusztikus				Rustik	11.39
	Andrea	11.34		Peblo	11.36		Menfi	11.38		Country	11.39
	Iroko	11.34		Boise O	11.36		Tomo	11.38		Gipa	11.40
	Ota	11.34		Joliet	11.36		Victoria	11.38		Sara	11.40
	Ruza	11.34		Recife II	11.36		Menfi	11.38		Margarita	11.40
	Jota	11.35		Hrazda	11.37		Tomo	11.38		Gipa	11.40

-  Sara 11.40
-  Margarita 11.41
-  Vintage 11.41
-  Serena 11.41
-  Vintage 11.41
-  Serena 11.41
-  Corsica 11.42
-  Cona 11.42
-  Loka 11.42
-  Bold 11.42
-  Kaniva 11.43

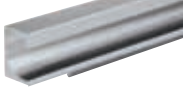
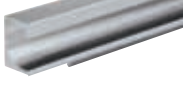

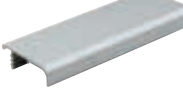







-  Panel F 11.43
-  Ring F 11.43
-  Avoca 11.44
-  Shellby 11.44
-  Misura 11.44
-  Anetta 11.44
-  Nave 11.44
-  Carpi 11.44
-  Gliss 11.45
-  Madrid 11.45
-  Rapid 11.45

-  Dunk 11.45
-  Rulida 11.45
-  Orinoco 11.45
-  Pesara 11.46
-  Malena 11.46
-  Concava 11.46
-  Lori II 11.47
-  Nary 11.47
-  Bowie 11.48
-  Lucata 11.48
-  Sophia 11.49





-  Ramara 11.49
-  Tende 11.50
-  Zoid 11.50
-  Juvio 11.51
-  Juvio L 11.51
-  Paolo 11.51
-  Paolo L 11.51
-  Fano 11.52
-  Lungo 11.52
-  Ria 11.52

fogantyúk és fogasok áttekintése

Fa és bőr

	Berga	11.61
	Metra	11.61
	Boise	11.61
	Lynn	11.61
	Beam	11.61
	Rail	11.61
	Mewo	11.62
	Xin	11.62
	Lines	11.62
	Mewo	11.62

	Vasca	11.62
	Tine	11.63
	Wave	11.63
	Ames	11.63
	Chico	11.63
	Moku	11.63
	Ames	11.63
	Square	11.64
	Taper	11.64
	Jacek	11.64
	Hole	11.64

	Jura	11.64
	Adam	11.65
	Bala	11.65
	Sola	11.65

Gyermekek

	Cute	11.66
	P431	11.66
	Spaccata	11.66
	Cute	11.66
	P439	11.66
	Spaccata	11.66

	Cana	11.67
	Palla	11.67
	Funga	11.67
	Bottone	11.67
	Large	11.68
	Into	11.68
	Filip	11.69

Fogasok

	Balo	11.69
	Troy	11.69
	Element	11.69

fogantyúk és fogasok áttekintése

	Rudi	11.69		Kara M	11.71		Cid XL	11.73		Orio	11.75
	Boise	11.69		Marell	11.71		Marcel XL	11.73		Murero XL	11.75
	Doris	11.70		Gant	11.72		Lugo XL	11.73		Rubico XL	11.75
	Rini	11.70		Dax	11.72		Muso	11.74		Orio XL	11.75
	Peri	11.70		Ener	11.72		Livorno	11.74		Balo XL	11.76
	Dyan	11.70		Gant XL	11.72		Darec	11.74		Xin	11.76
	Rini XL	11.70		Iwo	11.72		Lerico	11.74		Twist	11.76
	Peri XL	11.70		Ener XL	11.72		Rokos	11.74		Extendo XL	11.76
	Pera	11.71		Cid	11.73		Darec XL	11.74			
	Kara S	11.71		Marcel	11.73		Murero	11.75			
	Kara L	11.71		Lugo	11.73		Rubico	11.75			

fogantyúk és fogasok áttekintése

Marella



Vitruvio 11.77



Lama 11.77



Tonda 11.77



Torus 11.78



Linæ 11.79



Torus 11.78



Riva 11.78



Riva 11.78



Brera 11.79



Defense 11.79



Art Decó 11.80



Viaggio 11.80



Viaggio 11.80



Sirius 11.81



Columnæ 11.81



Macis 11.81



Columnæ 11.81



Macis 11.81



Augusto 11.82



Smarty 11.82



Aramis S 11.82



Tiberio 11.82



Jonathan 11.82



Aramis M 11.82

Hettich



Anzio 11.85



Bermeo 11.85



Intra 11.85



Salacia 11.86



Chalcis 11.86



Baldone 11.86



Naila 11.86



Catana 11.87



Salona 11.87



Balmo 11.87



Vantania 11.87



Egara 11.87



Genoa 11.87



Fermo 11.88



Coria 11.88



Monacum 11.88











Messana 11.88

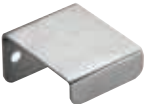

Haida 11.88

fogantyúk és fogasok áttekintése

	Almus	11.88
	Gela	11.89
	Gela a Galati	11.89
	Empoli	11.89
	Galati	11.89
	Aboa	11.89
	Narni	11.89
	Nidum	11.90
	Touch - in	11.90
	Touch - in	11.90

Tonk [Zamac]

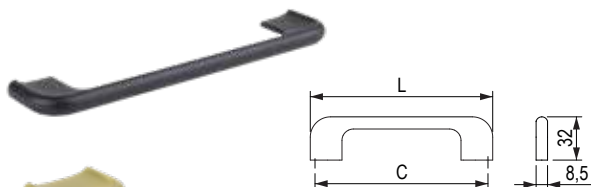

11.33 o.

nikkel csiszolt	matt fekete	csiszolt arany	furattávolság C (mm)	hossz L (mm)
489337	489336	489338	160	135
489340	489339	489341	320	167

Scoop [Zamac]

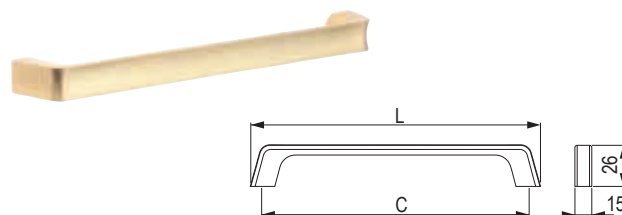

arany matt	matt réz	furattávolság C (mm)	hossz L (mm)
351843	351845	160	180
351844	351846	320	340

Scala [Alu]

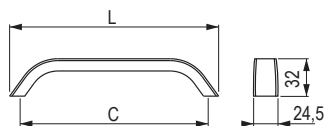

barna matt	eloxált alumínium	nemesacél imitáció	csiszolt fekete	furattávolság C (mm)	hossz L (mm)
×	227248	227239	544812	128	147
261978	227249	227240	378651	160	179
261979	227250	227242	378652	192	211
261980	227251	227243	378653	224	243
261981	227252	227244	378654	320	339
×	×	227245	378655	448	467
×	×	227246	378656	544	563
×	×	227247	378657	640	659

Peblo [PWC]

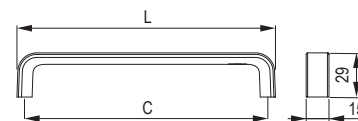

earth	beton	furattávolság C (mm)	hossz L (mm)
543774	543773	160	170

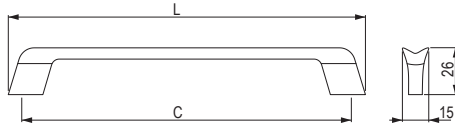

Wake [Zamac]



	furattávolság C (mm)	hossz L (mm)
401562	160	180
401563	320	340

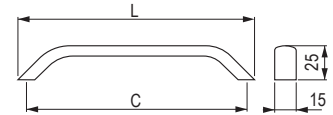

Marca [Alu]

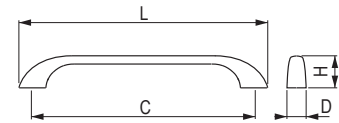

		furattávolság C (mm)	hossz L (mm)
225008	544813	160	197
225009	544814	192	229
225010	544815	224	261
225011	544816	320	357
225012	544817	448	485

Asama [Zn]



			furattávolság C (mm)	hossz L (mm)	szélesség D (mm)	magasság H (mm)
157231	157234	157228	160	204	17	26
157232	157235	157229	192	245	18	29

Umberto [Zamac]

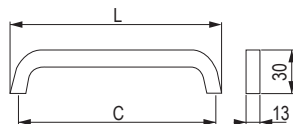

	furattávolság C (mm)	hossz L (mm)
192369	192	214
192370	256	278
192371	320	345
192372	448	470

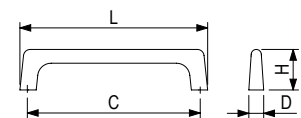

Cub [Zn]



			furattávolság C (mm)	hossz L (mm)	szélesség D (mm)	magasság H (mm)
494759	494758	494760	128	139	11	30
494762	494761	494763	192	203	11,8	31,3
494765	494764	494766	320	335	13,7	31,8

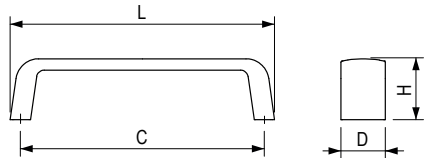

Iris [Alu]



		furattávolság C (mm)	hossz L (mm)	szélesség D (mm)	magasság H (mm)
nikkel csiszolt	matt fekete				
308974	544818	96	104	14	18,7
308975	544819	128	136	17	22,3
308976	544820	160	168	17,6	22,6
308977	544821	192	200	18,1	23,6

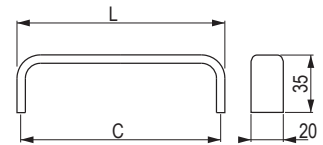

Muta [Alu]

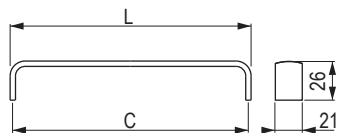

		furattávolság C (mm)	hossz L (mm)
eloxált alumínium	nemesacél imitáció		
36821	36829	128	136
36822	36830	160	168
36823	36831	192	200
36824	36832	224	232
36825	36833	320	328
36826	36834	448	456

Oga [Zn]





		furattávolság C (mm)	hossz L (mm)
króm matt	nikkel csiszolt		
157203	157199	96	102
157204	157200	128	134
157205	157201	160	166
157206	157202	192	198

Peca [Zn]

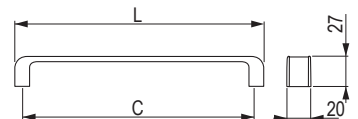

11.37 o.



		furattávolság C (mm)	hossz L (mm)
króm fényes/ nemesacél imitáció	króm fényes/ fehér matt		
225070	227260	128	142
225071	227261	192	206
225072	225066	256	270

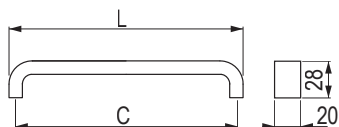

Recife [Zamac]

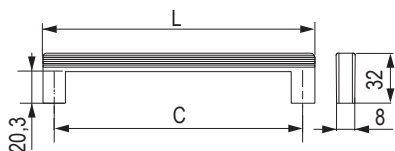

	furattávolság C (mm)	hossz L (mm)
157638	128	137
157639	192	201
157640	224	233
157641	256	265
157642	320	329
157643	448	457

Palm [Zamac]



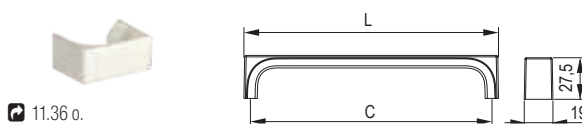

			furattávolság C (mm)	hossz L (mm)
547166	547164	547165	160	171

Recife II [Zamac]



11.36 o.

			furattávolság C (mm)	hossz L (mm)
543780	543779	543778	160	169
543783	543782	543781	320	329

Enuca [Zn]

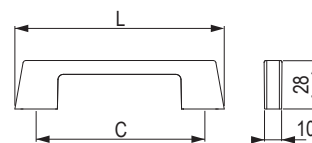

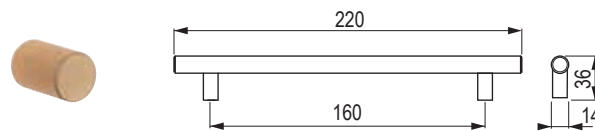

	furattávolság C (mm)	hossz L (mm)
284096	128	143
284097	160	190
284098	224	254
284099	320	352

Mella [Alu]



11.34 o.

	
396165	396164



Boise [Zamac]



11.61 o.



11.36 o.



11.36 o.

		furattávolság C (mm)	hossz L (mm)
csiszolt sötét arany	matt fekete	160	210
544832	544831		
546229	546228	320	370

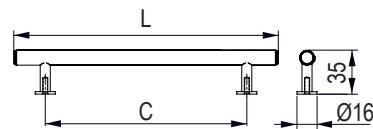

Joliet [Alu /zamac]



11.36 o.

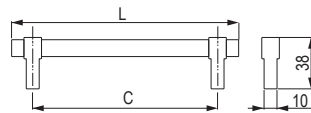

		furattávolság C (mm)	hossz L (mm)
champagne bronzé	steel grey/ matt fekete	160	190
547167	547170		
547168	547171	256	286
547169	547172	416	446

Cory [Alu]

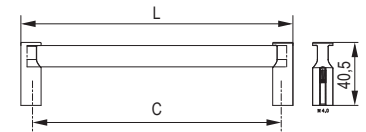

		furattávolság C (mm)	hossz L (mm)
lakkozott tölgy/ csiszolt fekete	csiszolt fekete	160	175
543754	543759		
543756	543757	320	335
543759	543755	1024	1039

Lenox [Zamac]

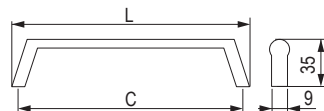

		furattávolság C (mm)	hossz L (mm)
matt fekete	csiszolt sötét arany	160	175
547158	547161		
547159	547162	224	239
547160	547163	320	335

Mount [Zn]

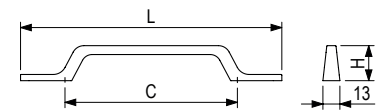

			furattávolság C (mm)	hossz L (mm)	magasság H (mm)
nikkel csiszolt	matt fekete	fehér matt	128	194	26
494749	494750	494751			
494752	494753	494754	192	258	27,2
494746	494747	494748	224	290	27,2

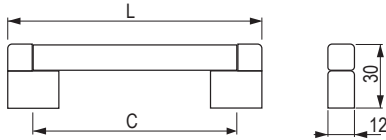

Resina [Zamac]



		furattávolság C (mm)	hossz L (mm)
matt fekete			
500450		128	152
500451		160	184
500452		192	216
500453		224	248
500454		256	280
500455		320	344
500456		384	408
500457		448	472
500458		480	504
500459		672	696
500460		736	760
500461		832	856
399520		960	984
500462		1056	1080
399522		1184	1208

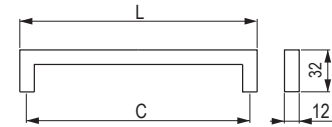

Marina [Stainless steel]

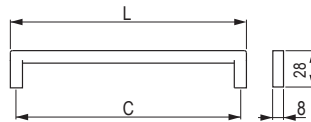

		furattávolság C (mm)	hossz L (mm)
csiszolt nemesacél	matt fekete		
203829	494687	128	140
203822	494680	160	172
203823	494681	192	204
203824	494682	224	236
203825	494683	320	332
203826	494684	480	492
203827	494685	640	652
203828	494686	736	748

Davide [Zamac]



		furattávolság C (mm)	hossz L (mm)
nikkel csiszolt	króm matt		
343940	343951	96	104
343941	343952	128	136
343942	343953	160	168
343943	343954	192	200
343944	343955	224	232
343945	343957	320	328



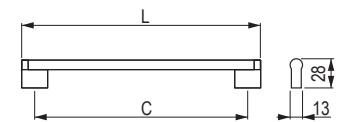



Penka [Zamac]

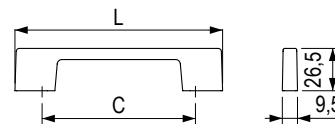

	furattávolság C (mm)	hossz L (mm)
nikkel csiszolt		
157250	128	136
157251	160	168
157252	192	200
157253	224	232
157255	320	328
157256	448	456



Nakana [Alu]

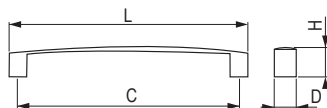

						furattávolság C (mm)	hossz L (mm)
fehér fényes	fekete fényes	matt fekete	króm matt	nikkel csiszolt	króm fényes	96	129
502023	502029	502035	502041	502047	502053	128	161
502024	502030	502036	502042	502048	502054	160	193
502025	502031	502037	502043	502049	502055	192	225
502026	502032	502038	502044	502050	502056	256	289
502027	502033	502039	502045	502051	502057	320	353
502028	502034	502040	502046	502052	502058		

Luca [Zamac]



			furattávolság C (mm)	hossz L (mm)	szélesség D (mm)	magasság H (mm)
króm matt	nemesacél imitáció	órány	128	141	21	22
224941	224945	359879	160	172	21,5	23
224942	224946	359881				



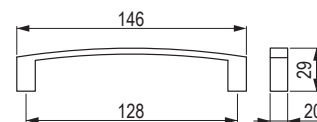

Menusa [Alu]

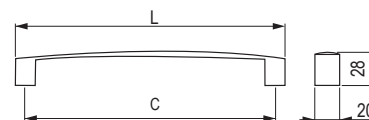

	előxált alumínium
35971	

Ulica [Zamac]



				furattávolság C (mm)	hossz L (mm)
nikkel csiszolt	króm fényes	nemesacél imitáció	króm matt	128	146
355912	303317	289690	289696	160	178
355913	303318	289691	289697	192	210
355914	303319	289692	289698	256	274
355915	303320	289693	289699	320	338
355916	303321	289694	289700		

Rocata [Alu]

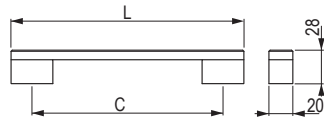

	furattávolság C (mm)	hossz L (mm)
284104	160	203
284105	224	267
284106	320	363

Lacata [Alu]

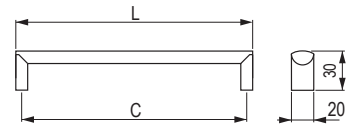

	furattávolság C (mm)	hossz L (mm)
227223	128	138
227224	160	170
227225	224	234
227226	320	330
227227	448	458

Sosa [Zn]

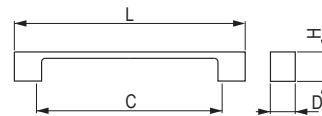

			furattávolság C (mm)	hossz L (mm)	szélesség D (mm)	magasság H (mm)
37031	37032	465322	160	190	20	24
37033	37034	465323	192	225	25	26

Bastone [Zamac]

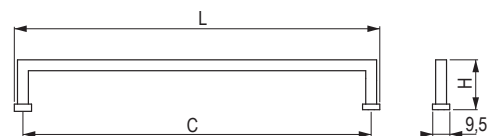

		furattávolság C (mm)	hossz L (mm)	magasság H (mm)
402388	402389	128	138	34
402391	402392	160	170	34
402453	402393	192	201,5	34
402394	402395	320	330	28

Ida [Fe]

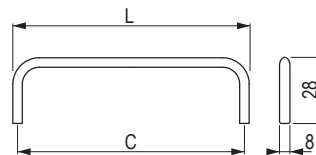

					furattávolság C (mm)	hossz L (mm)
35341	157542	157543	494659	494625	96	112
157544	157545	157546	494660	494626	128	146
231423	231424	231422	494661	494627	160	170

Kira [Alu]

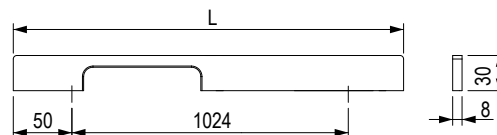
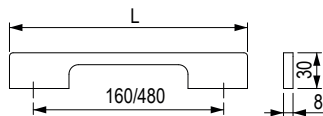
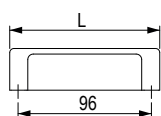

		furattávolság C (mm)	hossz L (mm)
494416	494415	96	108
494418	494417	160	200
494420	494419	480	500
494422	494421	1024	1200

Hrazda [Fe/Alu]



11.37 o.

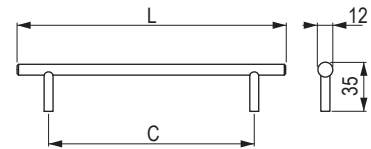

						furattávolság C (mm)	hossz L (mm)
35941	35942	35943	35947	10640	494607	96	136
35921	35922	35923	35927	10641	494608	128	168
35661	35662	35663	35667	10642	494609	160	200
36731	36732	36733	36737	10643	494610	192	232
35931	35932	35933	35937	10644	494611	224	264
36741	36742	36743	36747	10645	494612	288	328
35651	35652	35653	35657	10646	494613	320	360
35951	35952	35953	35957	10648	494614	448	488
35641	35642	35643	35647	×	494615	544	584
36751	36752	36753	36757	10652	494616	672	712

Porta [Alu]

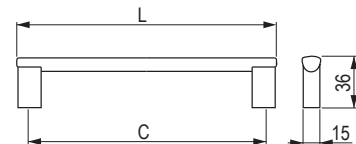

					furattávolság C (mm)	hossz L (mm)
371989	37909	179439	157786	465922	96	108
371990	37880	37980	157787	465923	128	140
371991	37881	37981	157788	465924	160	172
371992	37882	37982	157789	465925	192	204
371993	37883	37983	157790	465927	224	236
371994	37884	37984	157791	465928	256	268
371995	37885	37985	157792	465929	288	300
371996	37886	37986	157793	465930	320	332
371997	37887	37987	157794	465938	384	396
371998	37888	179441	157795	465937	432	444
371999	37889	37989	157796	465931	448	460
372000	37890	37990	157797	465932	480	492
372001	37891	37991	157798	465933	544	556
389788	37893	37993	157800	465934	672	684
389789	37894	37994	157801	465935	736	748
389791	37895	37995	157802	465936	768	780

Wakano [Alu]

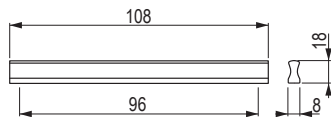
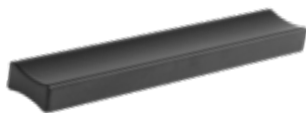

eloxált alumínium

36333



matt fekete

494694

Hytech [Alu]

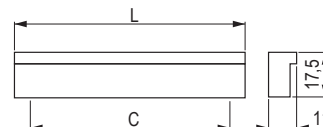

eloxált alumínium

190523

furattávolság
C (mm)

64

hossz
L (mm)

90

359390

96

120

359392

128

150

Jakoto II [Alu]

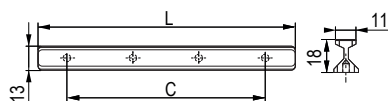

coffee
csiszolt

544793



steel grey
csiszolt

544795



fekete
csiszolt

544789

furattávolság
C (mm)

32

hossz
L (mm)

50

544794

544796

544790

128

150

x

x

544791

256

300

x

x

544792

1056

1200

Likano [Alu]

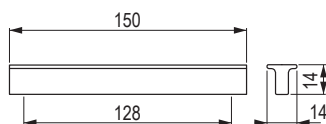

eloxált alumínium

36332

Zuzana [Zamac]

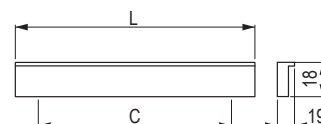

eloxált alumínium

35900

furattávolság
C (mm)

32

hossz
L (mm)

44

35898

128

140

Napa [Zamac]

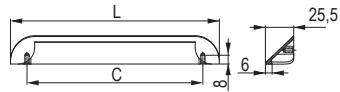

		furattávolság C (mm)	hossz L (mm)
544826	544825	160	190

Acri [Zamac]

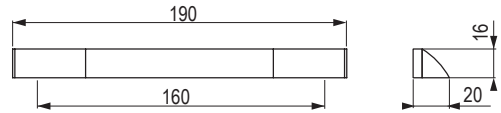

398580	398581	398582	398583	398584

Isola [Alu]

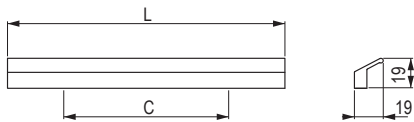

			furattávolság C (mm)	hossz L (mm)
227293	227297	227301	96	116
227294	227298	227302	160	180
227295	227299	227303	224	244

Yuma [Zamac]

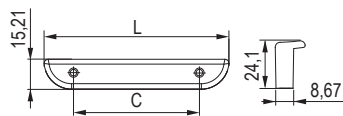

		furattávolság C (mm)	hossz L (mm)
543767	543766	64	94
543769	543768	224	254

Envel [Zamac]

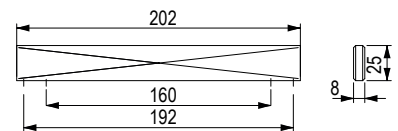

11.33 o.

482575	482574	482573

Sulky [Zamac]



ófekete
202828



ócsink
202830

Halti [Zamac]

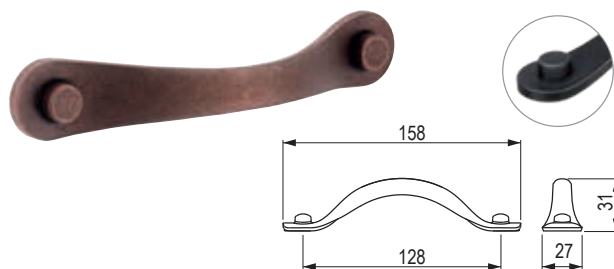

ófekete
351829



óréz
351832

Kentucky [Zamac]

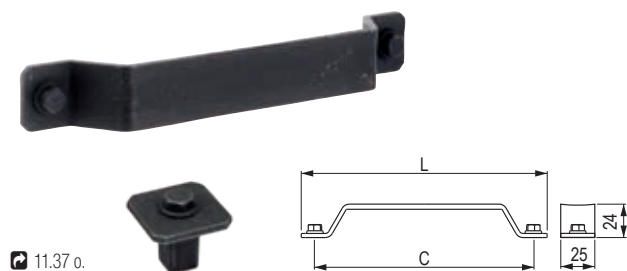

11.37 o.



ófekete
202844



ócsink
202846

furattávolság
C (mm)
160

hossz
L (mm)
180

202831

202843

192

212

Andrea [Zn]

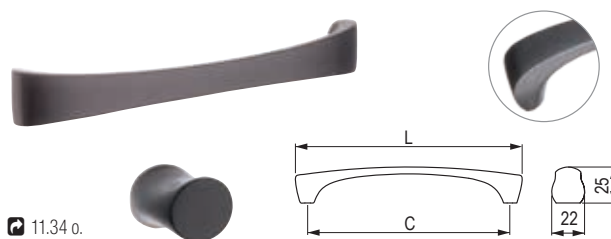

11.34 o.



sötét nikkelt
matt
351947

furattávolság
C (mm)
96

hossz
L (mm)
110

351948

128

142

351949

160

174

Kink [Zamac]

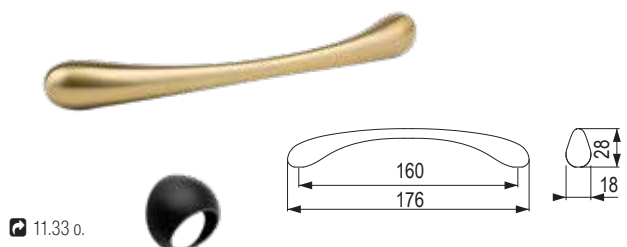

11.33 o.



nikkel csiszolt
482585



csiszolt sötét arany
482584



matt fekete
482583

Besina [Zamac]

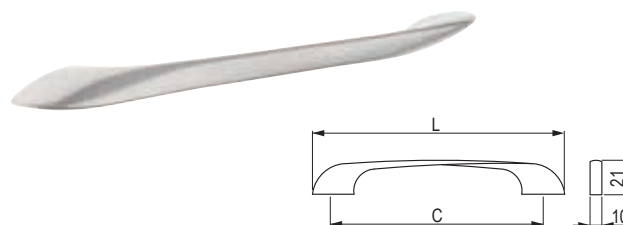

matt nikkelt
35471

furattávolság
C (mm)
96

hossz
L (mm)
121

35481

128

157

35491

160

190

Nomina [Zamac]

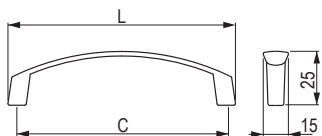

		furattávolság C (mm)	hossz L (mm)
157534	157535	96	108
35232	35231	128	140

Iluna [Zamac]

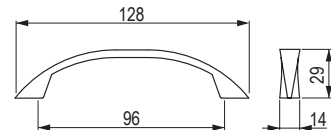

króm matt	nikkel csiszolt	matt nikkel
157527	157528	35301

Ruona [Zamac]

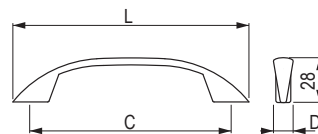

				furattávolság C (mm)	hossz L (mm)	szélesség D (mm)
35451	35452	35453	35455	96	132	15
35461	35462	35463	×	128	164	16



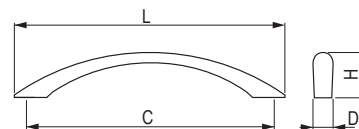



Piombina [Zamac]

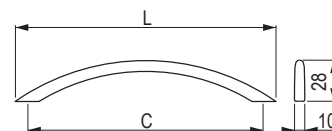

							furattávolság C (mm)	hossz L (mm)	szélesség D (mm)	magasság H (mm)
35251	35252	35253	35254	35255	157520	226980	96	127	12	24
35241	35242	×	×	35245	157521	×	128	164	14	28







Beta [Fe]

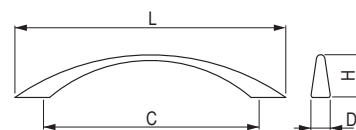

						furattávolság C (mm)	hossz L (mm)
35011	35012	35013	35015	35019	35017	96	114
35021	35022	35023	35025	157522	157523	128	146







Anita [Zamac]

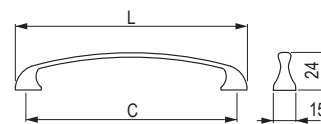

							furattávolság C (mm)	hossz L (mm)	szélesség D (mm)	magasság H (mm)
35071	35072	35073	×	35075		×	64	81	9	23
35081	35082	35083	35084	35085	35089	157525	96	115	10	28
35091	35092	35093	×	35095	×	157526	128	164	11	28



Uroso [Zamac]



						furattávolság C (mm)	hossz L (mm)
35631	35632	35633	494594	494593	494604	96	112
35141	35142	×	494603	494602	494605	128	146

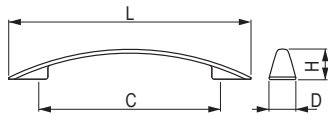

Unesa [Zamac]

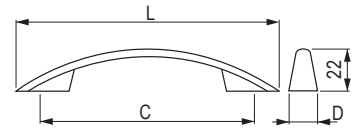

		furattávolság C (mm)	hossz L (mm)	szélesség D (mm)	magasság H (mm)
króm matt	nikkel csiszolt				
157529	157530	96	141	16	23
35412	157531	128	186	21	24
157532	157533	160	216	21	24

Vali [Zn]



		furattávolság C (mm)	hossz L (mm)	szélesség D (mm)
óréz sötét	ócsink csiszolt			
226960	226963	96	140	15
226961	226964	128	174	16
226962	x	160	206	16

Palin [Zamac]

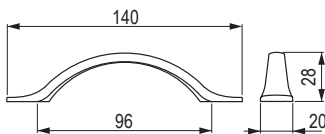

matt nikkel

35561

Sema [Alu]

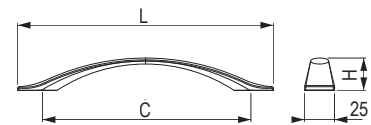

	furattávolság C (mm)	hossz L (mm)	magasság H (mm)
sötét nikkel csiszolt			
284053	128	181	27
284054	160	214	27
284055	256	309	29
284056	320	374	29

Kewina [Zamac]

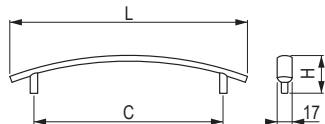

			furattávolság C (mm)	hossz L (mm)	magasság H (mm)
35161	35162	35163	96	124	25
35151	35152	35153	128	156	27

Sakita [Zamac]

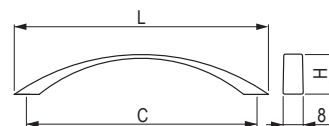

		furattávolság C (mm)	hossz L (mm)	magasság H (mm)
157556	157554	96	116	25
157723	157721	128	150	31

Pelena [Zn]

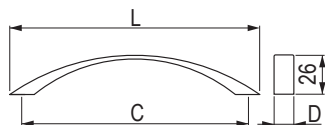

		furattávolság C (mm)	hossz L (mm)	szélesség D (mm)
157833	157825	128	140	19
157834	157826	160	174	20
37742	37741	192	228	20
157835	157827	224	257	20

Geneda [Zamac]

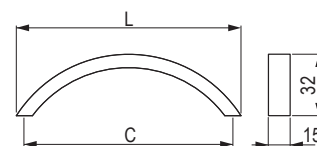

		furattávolság C (mm)	hossz L (mm)
35112	157537	96	108
157539	157540	128	140

Malada [Zamac]

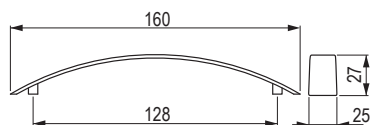

35832	35837

Fiona [Zamac]

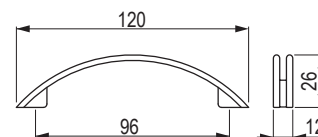

35041	35042	35043

Ruota [Zamac]

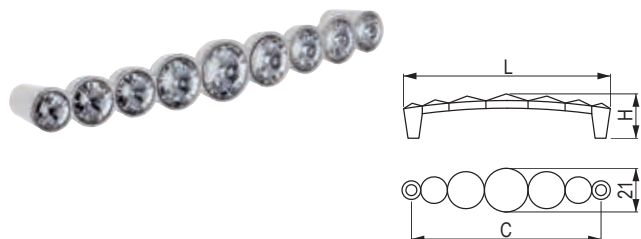

króm fényes	furattávolság C (mm)	hossz L (mm)	magasság H (mm)
US008	32	48	26
US007	96	114	30
US006	128	145	30

Enza [Zamac]

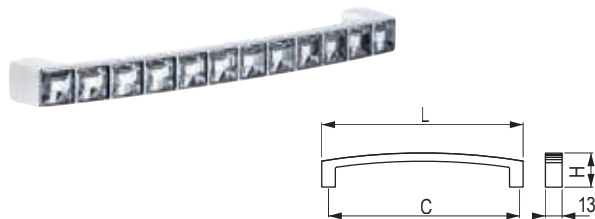

króm fényes	furattávolság C (mm)	hossz L (mm)	magasság H (mm)
US004	96	107	22
US001	128	140	25

Kutta [Zamac]

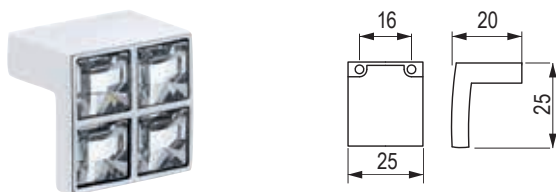

króm fényes
US005

Kutta [Zamac]

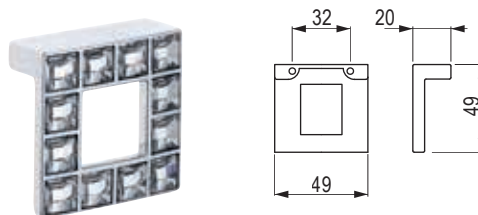

króm fényes
US002

Ruota [Zamac]

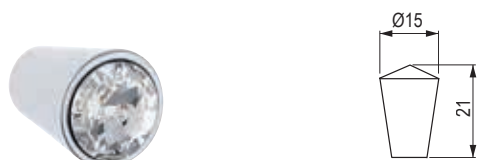

króm fényes
US011

Enza [Zamac]



króm fényes
US003



Blink [Zamac]

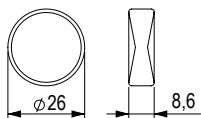

nikkel csiszolt

482578



csiszolt sötét arany

482577



matt fekete

482576

Envel [Zamac]

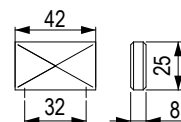

nikkel csiszolt

482572



csiszolt sötét arany

482570



matt fekete

482567

Tonk [Zn]

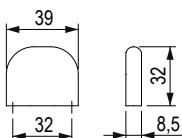

nikkel csiszolt

489334



csiszolt arany

489335



matt fekete

489333

Kink [Zamac]

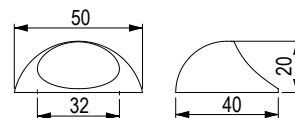

nikkel csiszolt

482582



csiszolt sötét arany

482581



matt fekete

482579

Mesa [Zamac]

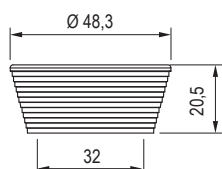

csiszolt arany

543764



barna matt

543765



matt fekete

543763

Bella [Zamac]

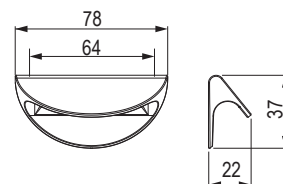

arany matt

396163



matt fekete

543785



Conic [Alu]

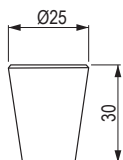

eloxált alumínium

401557



arany matt

401558



barna matt

401556



matt fekete

401555

Iroko [Zn]

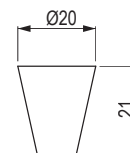

króm matt

37251



nikkel csiszolt

37252

Mella [Alu]

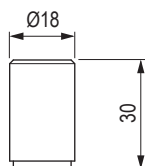

arany matt

396167



matt fekete

396166

Ota [Fe]

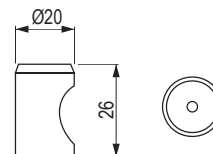

csiszolt nemesacél

202884

Andrea [Zamac]

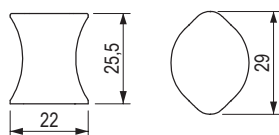

sötét nikkel matt

351946

Ruza [Zn]

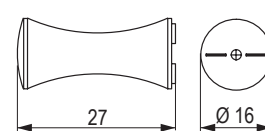

króm matt

157290



króm fényes

157292



nikkel csiszolt

157291



matt fekete

157293

Jota [Zamac]

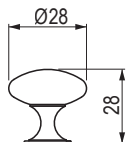

nikkel csiszolt	fehér fényes	matte nikkel	króm matt	króm fényes	arany fényes	arany matt	matte fekete
35007	401575	35001	35002	35003	35004	494606	35005

Evan [Zamac]

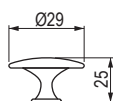

matte nikkel	króm matt	króm fényes	fekete fényes	matte fekete
401571	401572	401573	401574	401570

Marusa [Zamac]

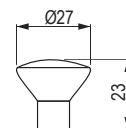

matte nikkel	króm matt	króm fényes
35171	35172	35173

Koby [Alu]

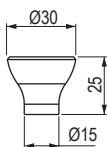

eloxált alumínium	barna matt	matte fekete
401561	401560	401559

Galka [Zamac]

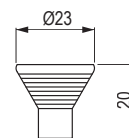

króm fényes	króm matt
289671	289672

Tomic [Zamac]

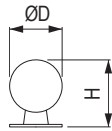

				szélesség D (mm)	magasság H (mm)
35261	35262	35263	×	18	23
35271	35272	35273	35274	25	32

Boise O [Zamac]

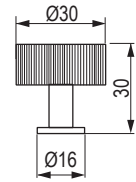

csiszolt sötét arany

544828



matt fekete

544827

Boise T [Zamac]

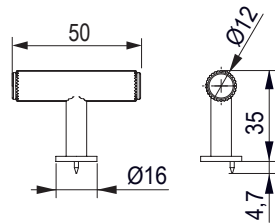

csiszolt sötét arany

544830



matt fekete

544829

Joliet [zamac/alu]

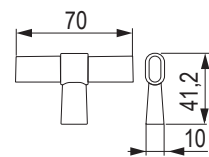

pezsgőbronz

547173



steel grey/ matt fekete

547175



champagne bronze /
steel grey

547174

Peblo [PWC]

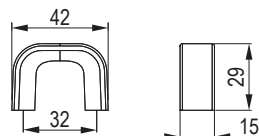

earth

543772



beton

543771

Recife II [Zamac]

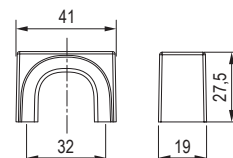

nikkel csiszolt

543776



barna matt

543777



matt fekete

543775

Hrazda [Fe/Alu]

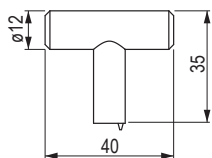

matt nikkel

402377



króm matt

402378



króm fényes

402379



nikkel csiszolt

402380



eloxált
aluminium

402381

Peca [Zn]

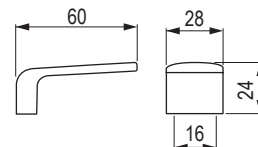

króm fényes/
nemesacél imitáció

246019



króm fényes/
fehér matt

246011

Tinto [Zamac]

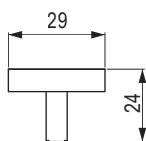

króm matt

36313



króm fényes

36314

Prisma [Alu]

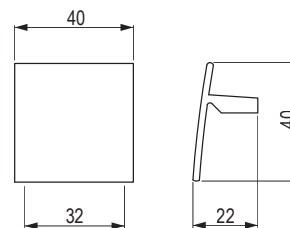

króm matt

42016



nemesacél imitáció

42017

Kentucky [Zamac]

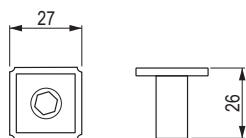

ófekete

351834



ócink

351836

Frame [Zamac]

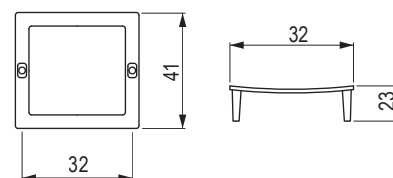

nemesacél imitáció

42096



matt fekete

396168

Menfi [Zamac]

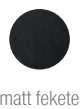
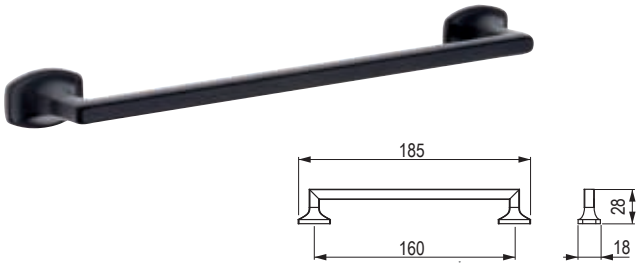

matt fekete

400314

Menfi [Zamac]

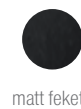

matt fekete

400316

Tomo [Zn]

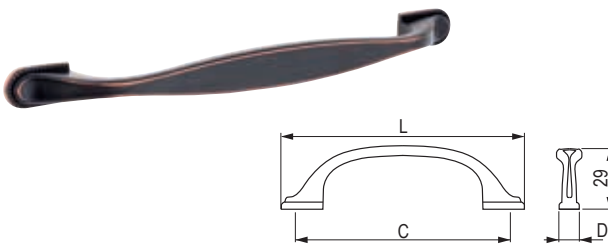

ócsink
csiszolt

226919

226921



óréz
sötét

226920

226922

furattávolság
C (mm)

96

160

hossz
L (mm)

132

204

szélesség
D (mm)

14

16

Tomo [Zn]



ócsink
csiszolt

226917



óréz
sötét

226918

Victoria [Zamac]

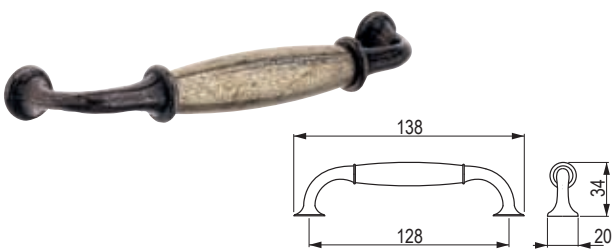

ófekete

42103



óbronz

157685

Victoria [Zamac]



ófekete

42104



óbronz

157684

Turia [Zn]

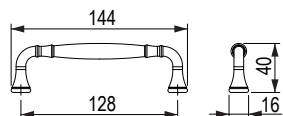

nikkel csiszolt

494695



órány

494710



matt fekete

494709

Turia [Zn]

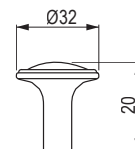

matt nikkel

157300



króm matt

157301



nikkel csiszolt

157302



króm fényes

157303



órány

157304



matt fekete

494679

Rusztik [Zamac]

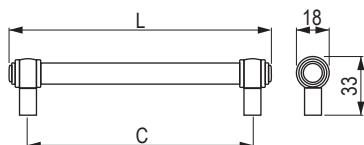

órány

296149



ócink csiszolt

296156

furattávolság C (mm)

128

hossz L (mm)

149

296150

296157

160

181

296154

296161

320

341

Rusztik [Zamac]

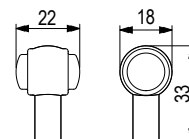

órány

296164



ócink csiszolt

296165

Country [Zamac]

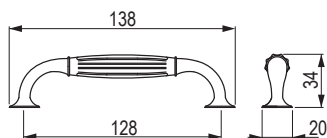

órány/
bézs porcelán

157681



óbronz/
bézs porcelán

42100

Country [Zamac]

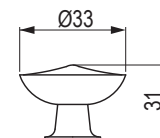
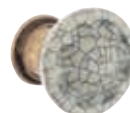

óbronz/
bézs porcelán

42102



órány/
bézs porcelán

157679

Gipa [Zamac]

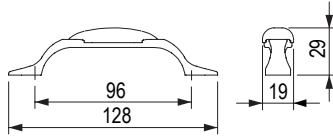

órány/fehér porcelán

309009



órány/repedezett porcelán

309010

Gipa [Zamac]

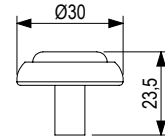

órány/fehér porcelán

309013



órány/repedezett porcelán

309012

Sara [Zamac]

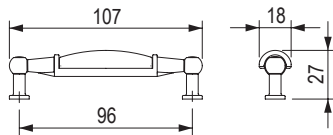

óáink/fehér porcelán

288823



órány/fehér porcelán

309006

Sara [Zamac]

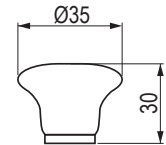

óáink/fehér porcelán

288820



órány/bézs porcelán

288821

Margarita [Zamac]

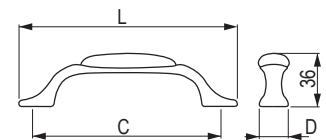

óáink/porcelán/motívum

288805



órány/porcelán/motívum

288808



óáink/fehér porcelán

288806



órány/bézs porcelán

288807



bárna/porcelán/motívum

288809

furattávolság C (mm)

96

hossz L (mm)

127

szélesség D (mm)

25

288800

288803

288801

288802

288804

128

159

26

Margarita [Zamac]



ócsink / porcelán/ motívum

288810



ócsink / fehér porcelán

288813



ócsink/fehér porcelán

288811



óarany/bézs porcelán

288812



barna/ porcelán/motívum

288814

Vintage [Zamac]

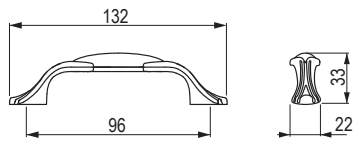

óarany/ porcelán/motívum

360611

Vintage [Zamac]

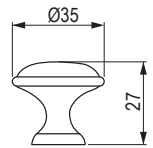

óarany/ porcelán/motívum

360609

Serena [Zamac]

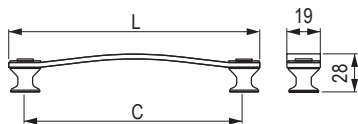

óarany

157283

furattávolság
C (mm)

128

hossz
L (mm)

147

Serena [Zamac]

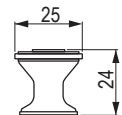

óarany

157285

Corsica [Zamac]

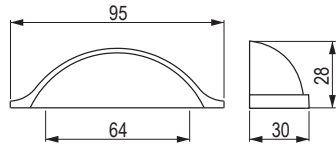

ófekete

202869

Loka [Zamac]

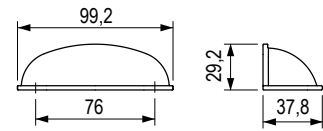

nikkel csiszolt

409056



arany matt

494174



matt fekete

494175

Cona [Zamac]

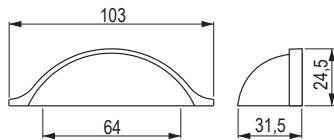

óarany

285004

Bold [Zamac]

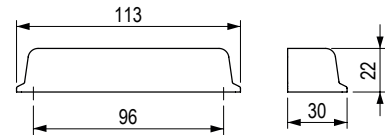

nikkel csiszolt

494195



matt fekete

494194

Panel F [Zamac]

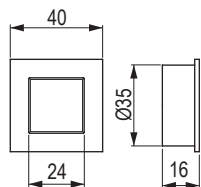

nikkel csiszolt

401584

Ring F [Zamac]

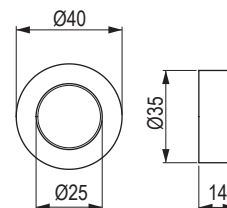

nikkel csiszolt

401588

Kaniva [Zamac]

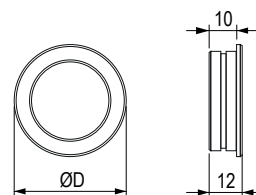

matt nikkel

35531

x



króm matt

35532

35542



króm fényes

35533

x



matt fekete

482746

482745

hossz
D (mm)

40

50

a mélyedés méretei
(bemarás) (mm)

35 × 35 × 10

42 × 42 × 10

Dunk [Zamac]

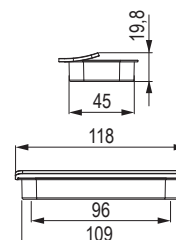

csiszolt arany

543761



barna matt

543762



matt fekete

543760

a mélyedés méretei
(bemarás) (mm)

109 × 45 × 13,5

Avoca [Zn]

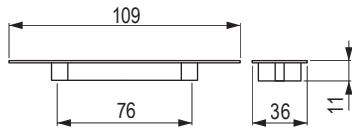

❗ Elsősorban tolóajtókhoz tervezett modell.

		a mélyedés méretei (bemarás) (mm)
króm matt	matt nikkel	
37771	37773	82 × 26,5 × 9

Anetta [Alu]

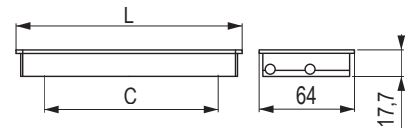

	furattávolság C (mm)	hossz L (mm)	a mélyedés méretei (bemarás) (mm)
eloxált alumínium			
37870	96	120	114 × 57,5 × 14,5
37871	128	150	144 × 57,5 × 14,5

Shellby [Zamac]

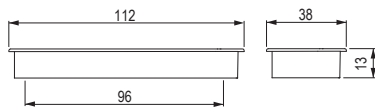

			a süllyesztés (bemarás) méretei (mm)
nikkel csiszolt	óbronz	matt fekete	
398092	398094	398095	107 × 31 × 12,5

Nave [Alu]



		furattávolság C (mm)	hossz L (mm)	a mélyedés méretei (bemarás) (mm)
eloxált alumínium	nemesacél imitáció			
225013	225017	96	106	101 × 36 × 11
225014	225018	160	170	166 × 36 × 11

Misura [Zamac]

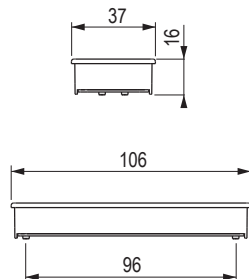

	a süllyesztés (bemarás) méretei (mm)
sötét arany	
506047	103 × 34 × 14

Carpi [Zamac]

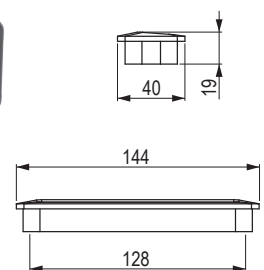

		a süllyesztés (bemarás) méretei (mm)
antracit	matt nikkel	
400311	400312	137 × 32 × 13

Gliss [Zamac]

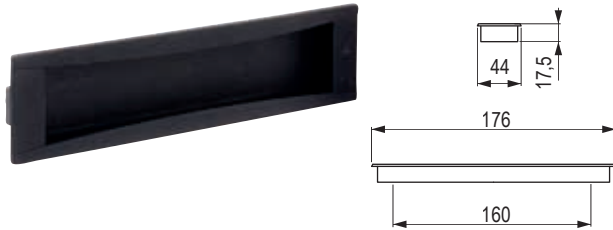

❗ Elsősorban tolóajtókhoz tervezett modell.

		a mélyedés méretei (bemarás) (mm)
ófekete	ócsink	
351940	351941	172 × 39 × 14

Madrid [Zamac]

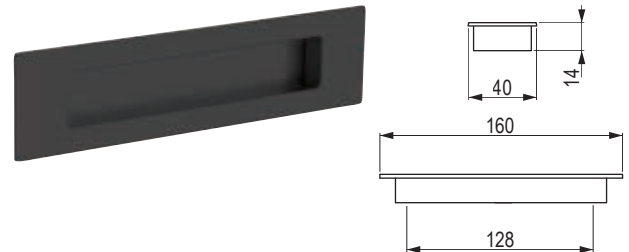

❗ Elsősorban tolóajtókhoz tervezett modell.

		a mélyedés méretei (bemarás) (mm)
ezüst	matt fekete	
36334	482586	142,6 × 30 × 12

Rulida [Alu]

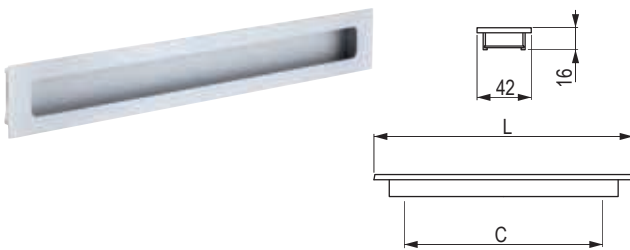

	furattávolság C (mm)	hossz L (mm)	a mélyedés méretei (bemarás) (mm)
eloxált alumínium			
37006	128	145	136 × 33 × 14
37007	256	278	267 × 33 × 14

Orinoco [Zn]

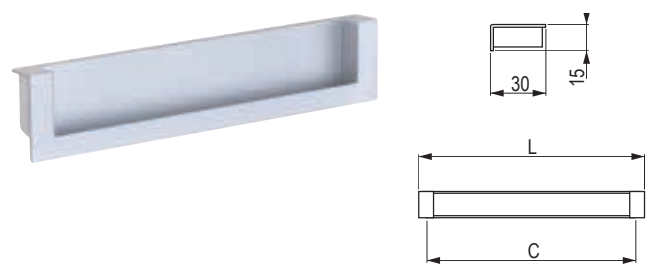

	furattávolság C (mm)	hossz L (mm)	a mélyedés méretei (bemarás) (mm)
ezüst			
157785	96	106	102 × 27 × 11
37201	128	138	134 × 27 × 11

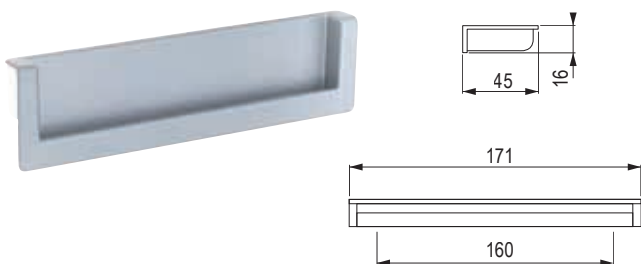

Rapid [Zamac]

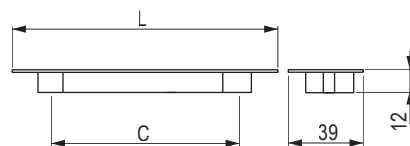

	a mélyedés méretei (bemarás) (mm)
ezüst	
215529	167 × 40 × 12,5

Pesara [Zn]



		furattávolság C (mm)	hossz L (mm)	a mélyedés méretei (bemarás) (mm)
157782	157783	96	107	102 × 28 × 10
157781	37781	128	139	135 × 28 × 10

Malena [Alu]

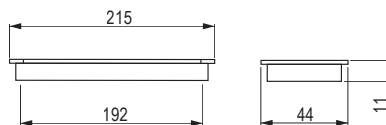

❗ Elsősorban tolóajtókhoz tervezett modell.





A köszönhetően a Malena fogantyú 18 mm vastag tolóajtókon is használható.

	a mélyedés méretei (bemarás) (mm)
226998	209 × 38 × 9

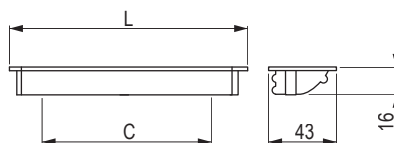

Concava [Zamac]



		furattávolság C (mm)	hossz L (mm)	a mélyedés méretei (bemarás) (mm)
37332	37333	96	109	103 × 36 × 14
157777	157778	128	140	137 × 36 × 14
37192	37193	160	171	167 × 36 × 14

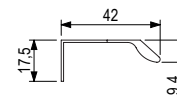
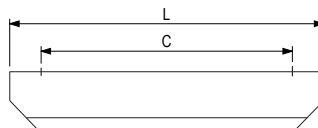



Lori II [Alu]

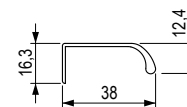
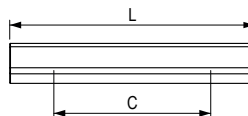

				
nemesacél imitáció	csiszolt sötét arany	csiszolt fekete	furattávolság C (mm)	hossz L (mm)
544802	544797	544807	64	80
544803	544798	544808	160	200
544804	544799	544809	256	350
544805	544800	544810	480	500
544806	544801	544811	1056	1200



Nary [Alu]



					
coffee matt	imitáció nemesacél	fekete matt	antracit	furattávolság C (mm)	Hossz L (mm)
544784	456882	456876	460523	32	50
x	456883	456877	460524	64	100
544785	456884	456878	460525	160	200
x	456885	456879	460526	256	300
544786	456886	456880	460527	352	400
x	456887	456881	460528	480	500
x	544788	544787	x	1056	1200

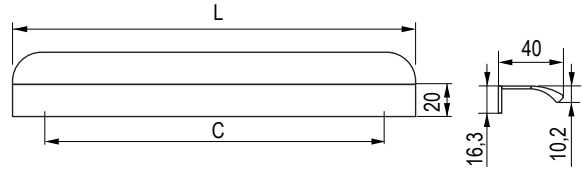





Bowie [Alu]

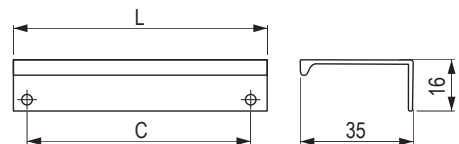

				
coffee csiszolt	csiszolt sötét arany	fekete csiszolt	furattávolság C (mm)	hossz L (mm)
544766	544772	544778	32	50
544767	544773	544779	64	100
544768	544774	544780	160	200
544769	544775	544781	256	350
544770	544776	544782	480	500
544771	544777	544783	1056	1200



Lucata [Alu]



							
fehér matt	króm fényes	nemesacél imitáció	eloxált alumínium	csiszolt arany	matt fekete	furattávolság C (mm)	hossz L (mm)
360347	227265	227271	227276	474383	360352	32	52
360348	227266	227272	227277	474384	360353	64	84
360349	227267	227273	227278	474385	360354	96	116
360350	227269	227274	227279	474386	360355	160	180
360351	227270	227275	227280	474387	360356	320	340
354155	354158	354153	354152	474388	354154	480	500
x	x	494663	284334	x	494662	x	3000

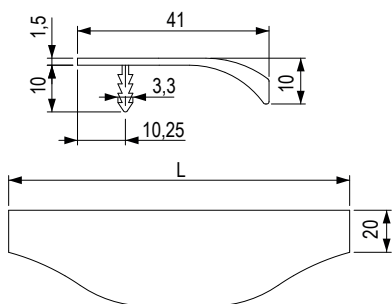

Sophia [Alu]

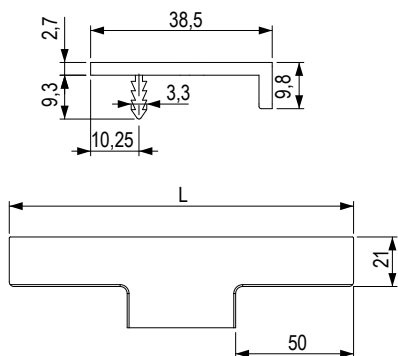

		hossz L (mm)
494256	494266	146
494248	494261	196
494674	494673	246
494246	494263	296
494247	494264	346
494253	494265	396
494250	494262	446
494249	494267	496
368532	494666	546
494252	494268	596
494254	494269	696
494255	494270	796
494251	494271	896
494257	494272	996
494258	494273	1196

Ramara [Alu]



			hossz L (mm)
244831	244834	366458	146
244832	244835	366459	196
487951	487953	487954	246
202816	244836	366460	296
202817	244837	366461	346
244833	244838	366462	396
202818	244839	366463	446
202819	244840	366464	496
494678	494677	494676	546
202820	244841	366465	596
487955	487956	487957	696
202821	244842	366466	796
202822	244843	366467	896
202823	244844	366468	996
202824	244845	366469	1196

Tende [Alu]

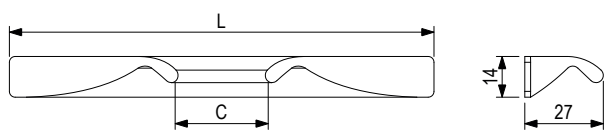

				furattávolság C (mm)	Hossz L (mm)
456845	456858	456819	456832	16/32	146
456846	456859	456820	456833	32/64	196
456847	456860	456821	456834	128/160	296
456848	456861	456822	456835	160/224	346
456849	456863	456823	456836	192/256	396
456850	456866	456824	456837	224/288	446
456851	456867	456825	456838	288/352	496
456852	456869	456826	456839	384/448	596
456853	456870	456827	456840	480/544	696
456854	456871	456828	456841	576/640	796
456855	456872	456829	456842	672/736	896
456856	456873	456830	456843	768/832	996
456857	456874	456831	456844	960/1024	1196

Zoid [Alu]

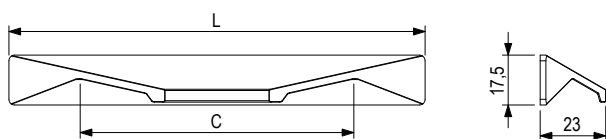

				furattávolság C (mm)	Hossz L (mm)
456762	456784	456799	456748	64/96	146
456770	456785	456800	456749	64/96	196
456771	456786	456801	456750	128/160	296
456772	456787	456802	456751	160/224	346
456775	456788	456803	456752	192/256	396
456776	456789	456804	456753	224 /288	446
456777	456791	456805	456754	288 /352	496
456778	456792	456806	456755	384 /448	596
456779	456793	456807	456756	480 /544	696
456780	456794	456808	456758	576 /640	796
456781	456795	456809	456759	672/736	896
456782	456796	456810	456760	768 /832	996
456783	456797	456811	456761	960 /1024	1196

Juvio [Alu]

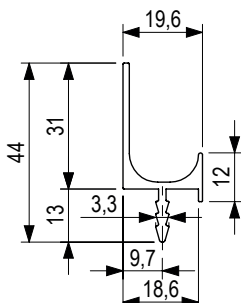
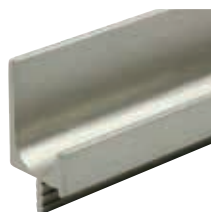

				hossz L (mm)	laminátum vastagsága (mm)
506395	506406	x	x	297	18
506396	506407	x	x	347	18
506397	506408	x	x	397	18
506398	506409	x	x	447	18
506399	506410	x	x	497	18
506400	506411	x	x	597	18
506401	506412	x	x	697	18
506402	506413	x	x	797	18
506403	506414	x	x	897	18
506404	506415	x	x	997	18
506405	506416	x	x	1197	18
276815	276814	466366	466365	2900	18

Paolo [Alu]

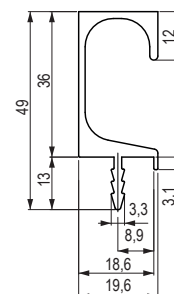
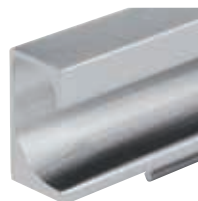

				hossz L (mm)	laminátum vastagsága (mm)
506366	506384	x	x	297	18
506367	506385	x	x	347	18
506368	506386	x	x	397	18
506369	506387	x	x	447	18
506370	506388	x	x	497	18
506371	506389	x	x	597	18
506374	506390	x	x	697	18
506376	506391	x	x	797	18
506377	506392	x	x	897	18
506378	506393	x	x	997	18
506379	506394	x	x	1197	18
276820	276821	466371	466368	2900	18

Juvio L [Alu]

- Profil 19-20 mm vastag ajtókhöz.

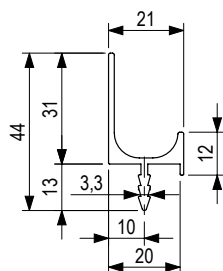

		hossz L (mm)	laminátum vastagsága (mm)
494712	494711	2900	20

Paolo L [Alu]

- Profil 19-20 mm vastag ajtókhöz.

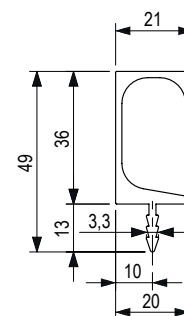

		hossz L (mm)	laminátum vastagsága (mm)
494714	494713	2900	20

Fano [Alu]

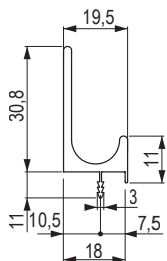

eloxált alumínium	matte fekete	hossz L (mm)	laminátum vastagsága (mm)
UC001	399431	2450	18

Ria [Alu]

• Profil a ferdén vágott élre

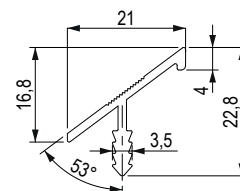

eloxált alumínium	matte fekete	nemesacél imitáció	hossz L (mm)	bútorlap vastagsága (mm)
491992	491993	491994	2900	18

Lungo [Alu]

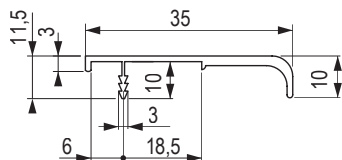
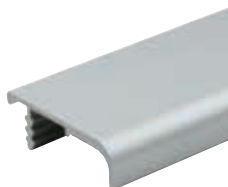

eloxált alumínium	hossz L (mm)	bútorlap vastagsága (mm)
UC004	2950	18



Gola rendszer

Az ajtók fogantyú nélküli nyitására szolgáló rendszer. Tartalmazza a vízszintes és függőleges profilokat (gardrób szekrényekhez és konyhai összeállításokhoz, padlótól a mennyezetig beépítve).



Vízszintes ajtó „J” profil.

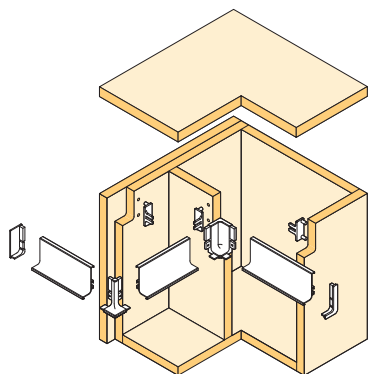

Vízszintes fiók „C” profil.

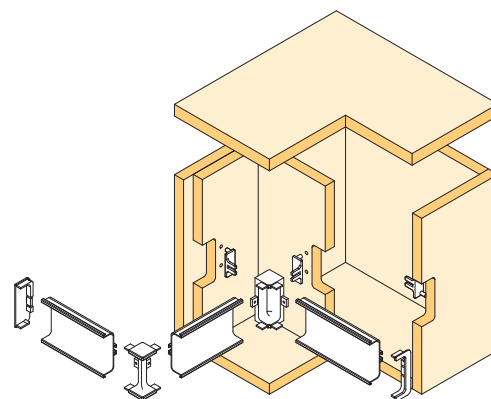

függőleges profilok (oldalsó és középső)

Gola vízszintes profilok

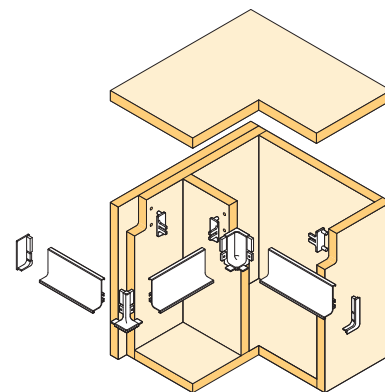
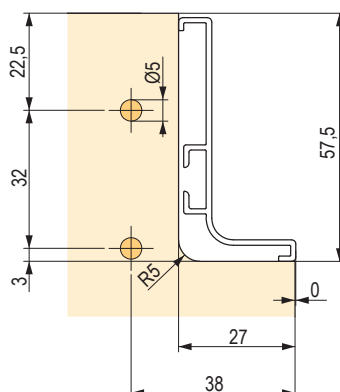
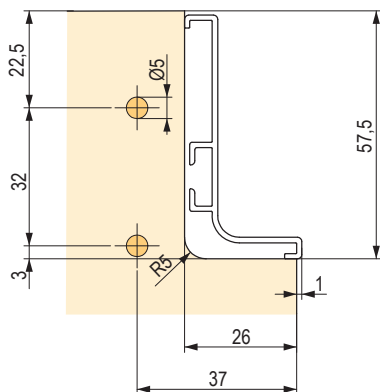

Vízszintes ajtó J profil 4100 mm

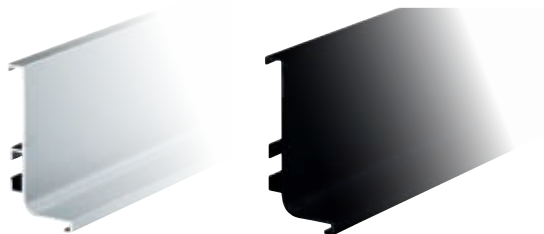

imitáció nemesacél	eloxált alumínium	fehér félfényes	fekete matt	csiszolt sötét arany
228304	151631	284149	404389	502335

- profil a munkalap alá
- a megadott szerelési méretek érvényesek, ha a profil átnyúlása meghaladja az 1 mm-t
- amennyiben a profilt síkba akarja szerelni növelje 1-el (37⇒38, 26⇒27)

Nyitott ajtóprofil végzáró

1.

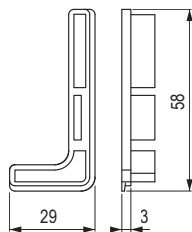

2.

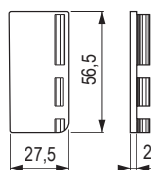

3.

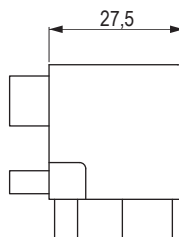

4.

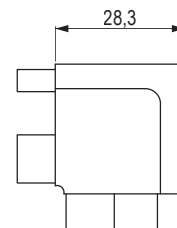

	ezüst	fehér	fekete	imitáció nemesacél	eloxált alumínium	fekete matt	csiszolt sötét arany	fehér félfényes	
	MŰANYAG			FÉM					
1	nyitott végzáró	232861	289124	404394	228305	151632	404397	502337	x
2	zárt végzáró	284152	289121	404392	284150	284151	404399	502338	x
3	külső sarok	x	x	x	228306	151717	404393	502339	284153
4	belső sarok	x	x	x	228307	151718	404391	502340	284154

• J + B végzáró szett

C fiókprofil 4 100 mm



imitáció
nemesacél

228308



eloxált
alumínium
alumínium

151732



félfényes fehér

284155



fekete

404404



csiszolt sötét
arany

502336

- profil egymás feletti fiókok közötti használatra
- a megadott szerelési méretek érvényesek,

- ha a profil átnyúlása meghaladja az 1mm-t
- amennyiben a profilt síkba akarja süllyeszteni, növelje 1-el (37 ⇒ 38, 26 ⇒ 27)

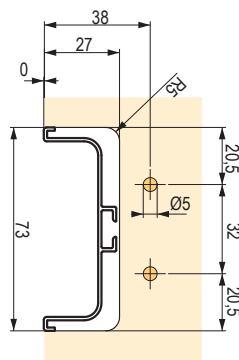
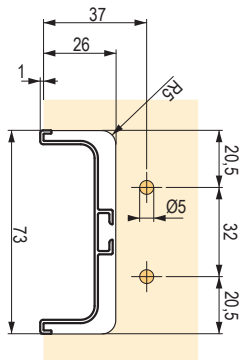

Nyitott fiókprofil végzáró

1.

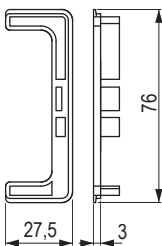

2.

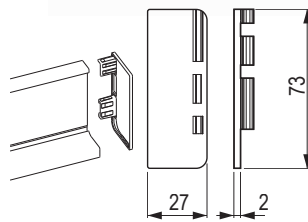

3.

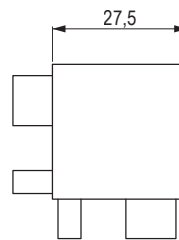

4.

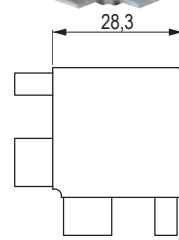

ezüst



fehér



fekete



imitáció
nemesacél



eloxált
alumínium
alumínium



fekete
matt



csiszolt sötét
arany



fehér
félfényes

leírás	MŰANYAG			FÉM				
	ezüst	fehér	fekete	imitáció nemesacél	eloxált alumínium alumínium	fekete matt	csiszolt sötét arany	fehér félfényes
1 nyitott végzáró	232862	289123	404414	228309	151785	404415	502341	×
2 zárt végzáró	284158	289122	404406	284156	284157	404417	502342	×
3 külső sarok	×	×	×	228310	151786	404413	502343	284159
4 belső sarok	×	×	×	228311	151821	404405	502344	284160

- J + B végzáró szett
- csak akkor használható, ha a profil nem a szekrény oldalai között van

Fiók és ajtóprofil rögzítőelem

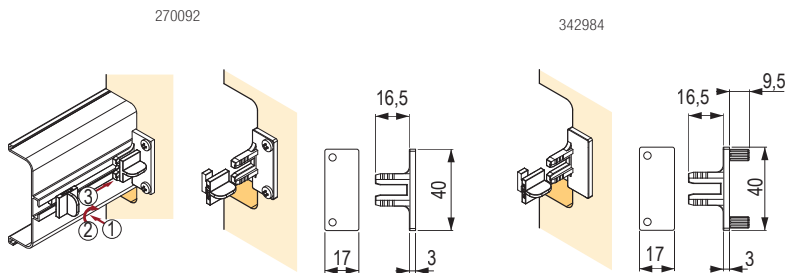

műanyag	műanyag, rögzítőelem tuskéval
270092	342984

- 2 db-os rögzítőelem-szett a profil szekrényoldalakhoz történő rögzítéséhez
- a helytakarékos megoldás lehetővé teszi a profil szerelését már beépített szekrényekbe

J ajtóprofil LED-el 4 100 mm

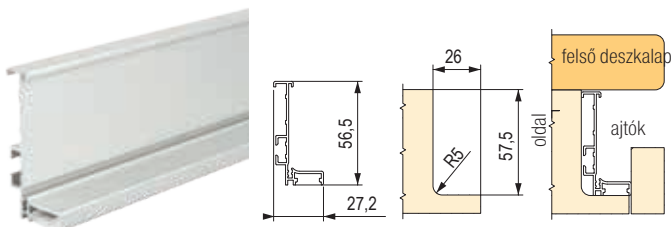

imitáció nemesacél	eloxált alumínium	fehér félfényes	fekete matt	sötét arany csiszolt
504523	504524	504525	504526	504527

- ❶ A LED szalag nem tartozék, külön kell megrendelni.
- ❷ Szükséges kiegészíteni 504528 takaró profillal.

- profil a munkalap alá
- a megadott szerelési méretek érvényesek, ha a profil átnyúlása meghaladja az 1 mm-t
- amennyiben a profilt sikba akarja süllyeszteni, növelje 1-el (37 ⇒ 38, 26 ⇒ 27)

C fiókprofil LED-el 4 100 mm

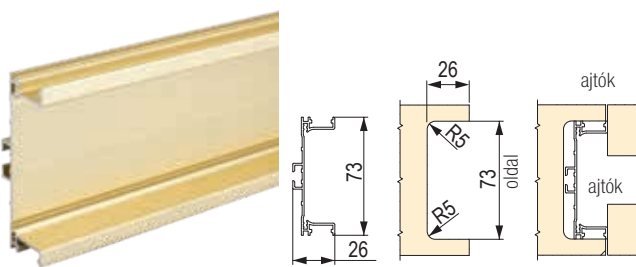

imitáció nemesacél	eloxált alumínium	fehér félfényes	fekete matt	csiszolt sötét arany
505493	505494	505495	505496	505485

- ❶ A LED szalag nem tartozék, külön kell megrendelni.
- ❷ Szükséges kiegészíteni 504528 takaró profillal.

- profil egymás feletti fiókok közötti használatra
- a megadott szerelési méretek érvényesek, ha a profil átnyúlása meghaladja az 1 mm-t
- amennyiben a profilt sikba akarja süllyeszteni, növelje 1-el (37 ⇒ 38, 26 ⇒ 27)

Gola takaróprofil (diffúzor) J és C ajtóprofilhoz LED-el 4,1m

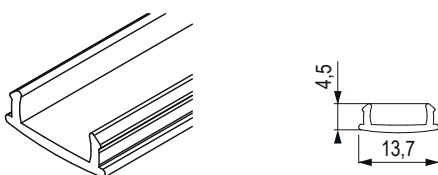

áttetsző műanyag

504528

Gola függőleges profilok a szekrényajtók fogantyú nélküli nyitásához

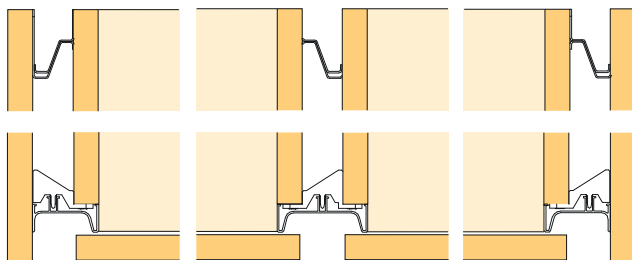

Panel szélessége



Snap on élprofil 2700 mm

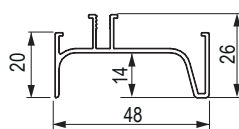
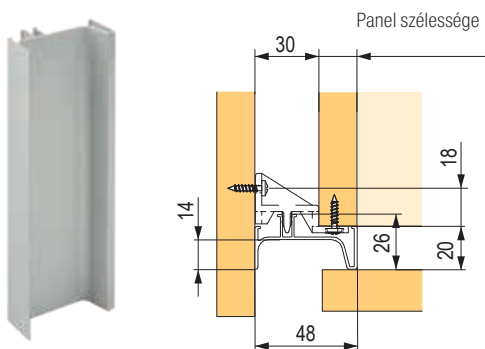

nemesacél imitáció

502345

eloxált alumínium

502346

fehér félfényes

502348

matt fekete

502349

csiszolt sötét arany

502350

Snap on középső profil 2700 mm

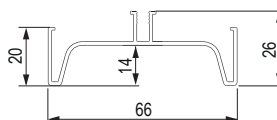
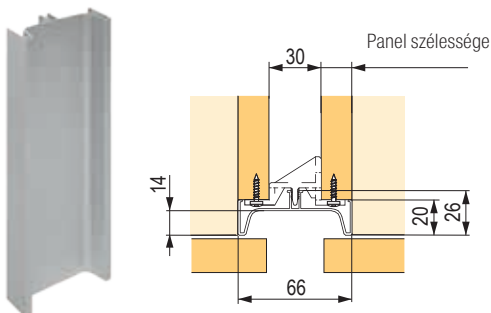

nemesacél imitáció

502351

eloxált alumínium

502352

fehér félfényes

502353

matt fekete

502354

csiszolt sötét arany

502355

Tartozékok a Snap on függőleges profilokhoz

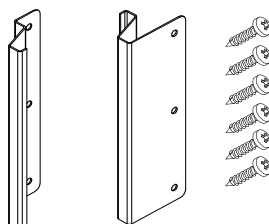

kód

leírás

504520

fém elhatároló darab a perem- és közép-re szerelhető profilhoz

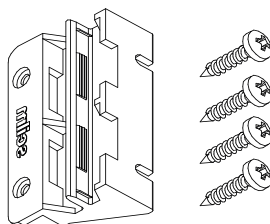

kód

leírás

504521

műanyag Snap on rögzítő elem élprofilhoz

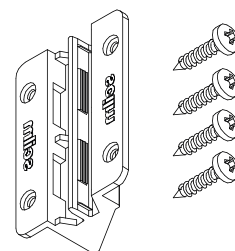

kód

leírás

504522

műanyag Snap on rögzítő elem a középső profilhoz



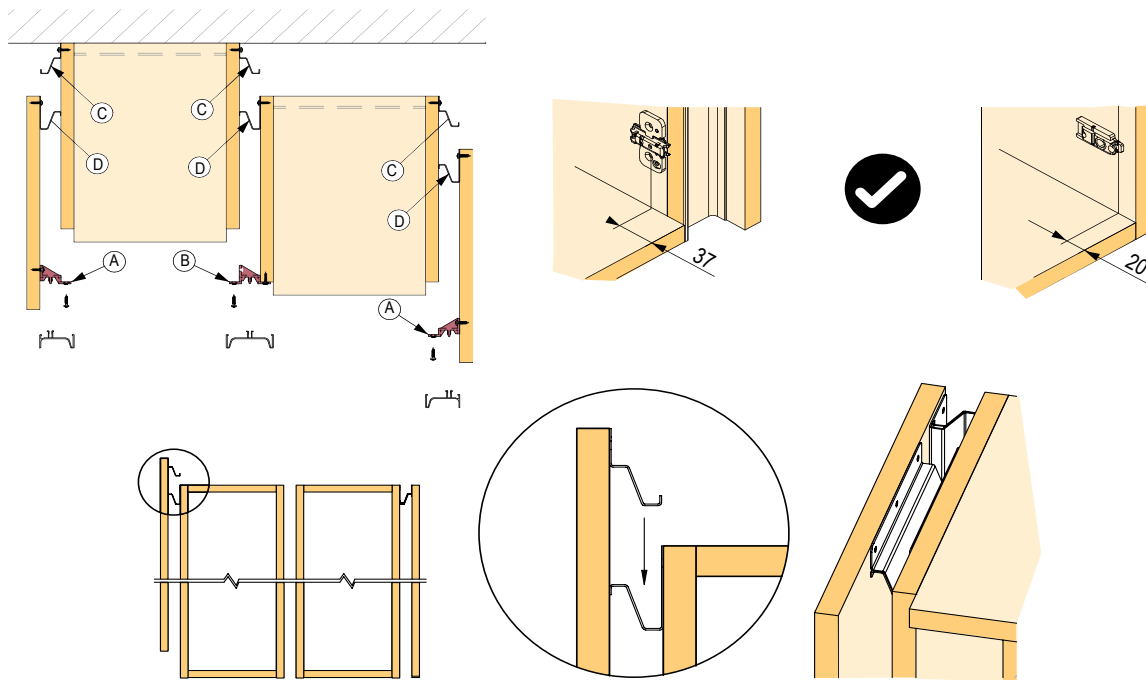

• anyag: műanyag

Tartozékok a Snap on függőleges profilokhoz

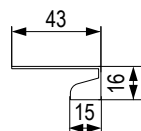
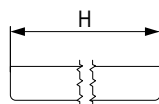

Gola Profil 1275 beépített sütőhöz



				hossz (mm)
547280	529673	529674	529673	580

- hővédelem
- a profil Snap on függőleges profilokkal kombinálva használható

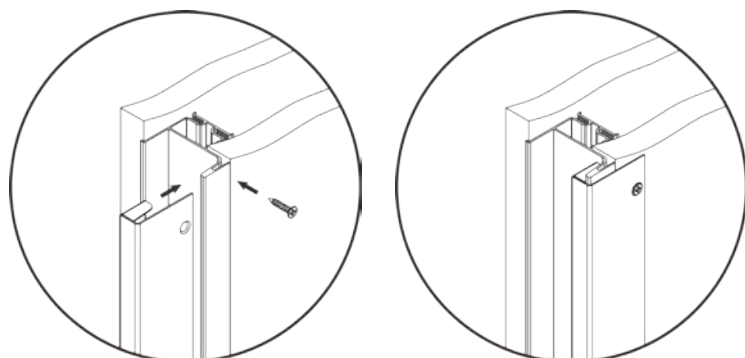

süllyesztett fogantyúk és profilok

3900 mm-es ajtóprofil felső szekrényekhez

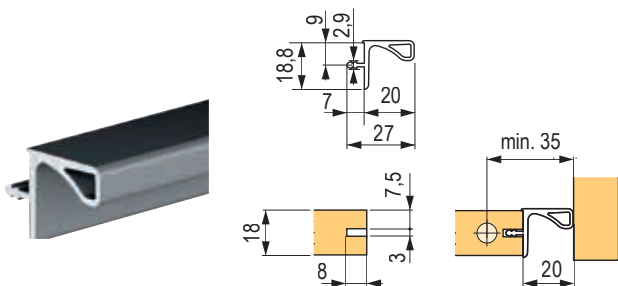

228312	156848	360875	502356	502364

3 900 mm-es ajtóprofil felső szekrényekhez tömítéssel

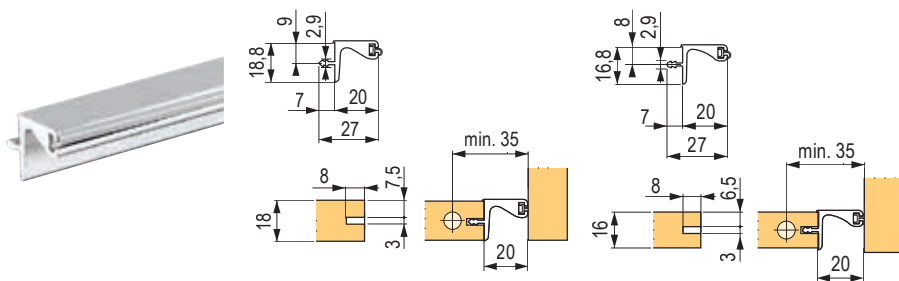

	vastagság (mm)
366368	18
302379	16

Rápattintható profilok 18 mm vastagságú anyaghoz

CD0051

313756

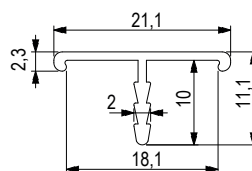
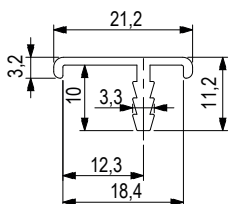

	hossz L (mm)
313756	2 900

J ajtóprofil 2 900 mm (profil a munkalap alá)

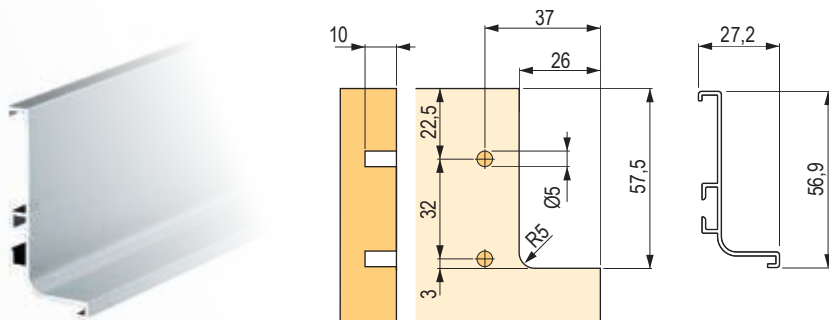

313754	313753

C fiókprofil 2 900 mm

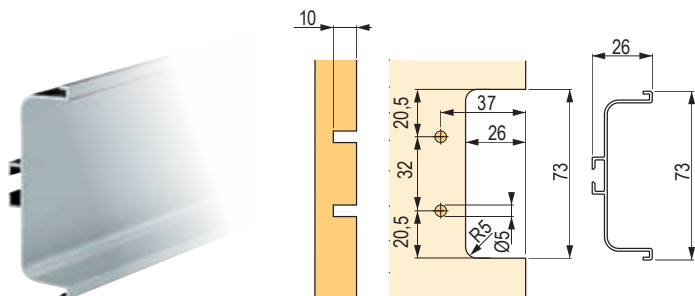

313752	313751

Fiók és ajtóprofil rögzítőelem

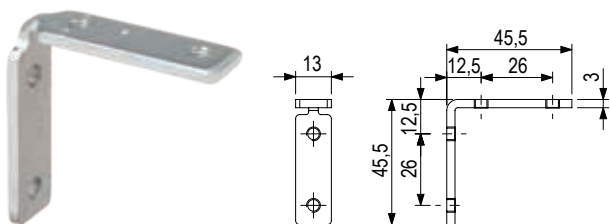

fém
313762

- J + B végzáró szett
- csak akkor használható, ha a profil nem a szekrény oldalai között van

Fiókprofil végzáró

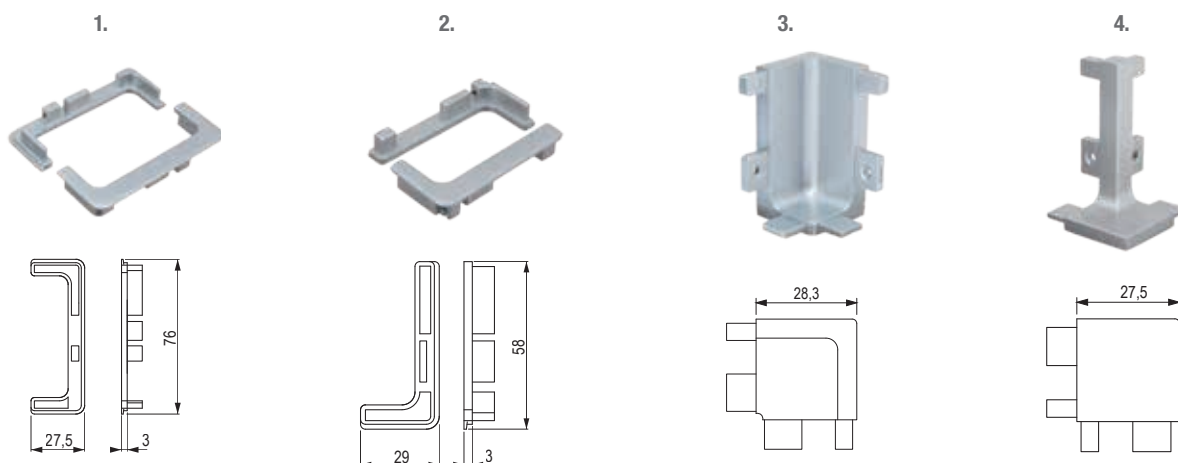

		leírás
1	313758	nyitott végzáró
2	313757	nyitott végzáró
3	313759	külső sarok
4	313760	belső sarok

- J + B végzáró szett
- csak akkor használható, ha a profil nem a szekrény oldalai között van

Berga

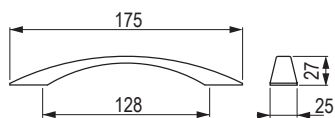

lakkozott tölgy

09459



lakkozott bükk

09461

Beam

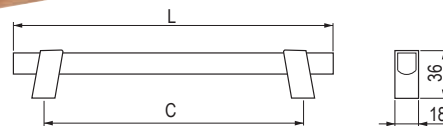

lakkozott tölgy

402330

502357

furattávolság C (mm)

192

320

hossz L (mm)

242

370

Metra

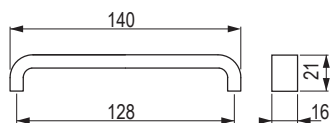

lakkozott tölgy

351899



lakkozott bükk

351900

Rail

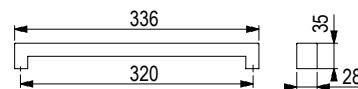

natúr tölgy

500446



lakkozott tölgy

500447



natúr kőris

500448



lakkozott kőris

500449

Lynn

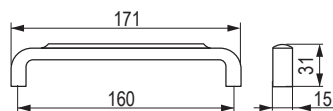

lakkozott dió

543785

furattávolság C (mm)

160

hossz L (mm)

171

Boise

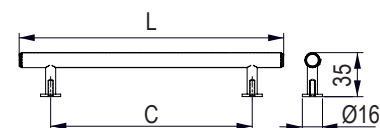

lakkozott tölgy/
csiszolt sötét arany

549438

549440



lakkozott tölgy/
matt fekete

549437

549439

furattávolság
C (mm)

160

320

hossz
L (mm)

210

370

Mewo

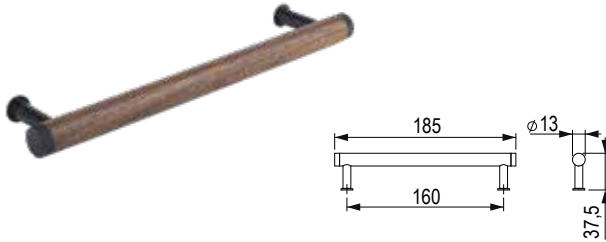

dió/matt fekete	dió/matt arany
497966	497967

Mewo



dió/matt fekete	dió/matt arany
497964	497965

Xin



						furattávolság C (mm)	hossz L (mm)
natúr tölgy	lakkozott tölgy	lakkozott dió	lakkozott tölgy/ fekete	lakkozott tölgy/ fehér	lakkozott tölgy/ szürke		
500434	500435	500436	x	x	x	32	60,5
500422	500423	500424	500425	500426	500427	192	225
500428	500429	500430	500431	500432	500433	996	1031

Lines

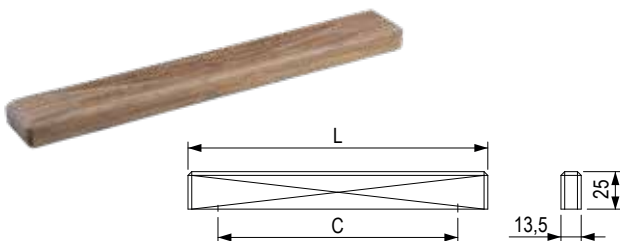

			furattávolság C (mm)	Hossz L (mm)
natúr tölgy	lakkozott tölgy	lakkozott dió		
500440	500441	500442	160	200
500443	500444	500445	480	520

Vasca

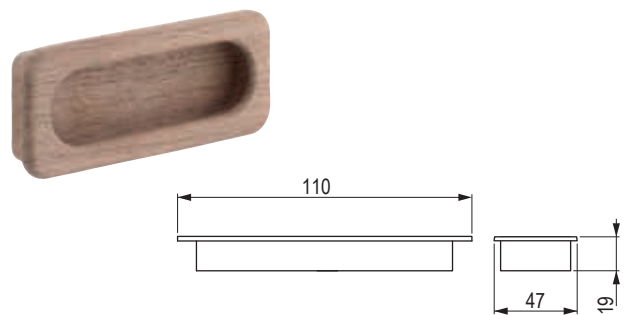

		a mélyedés méretei (bemarás) (mm)	mélység (mm)
natúr tölgy	natúr bükk		
351888	351889	100 × 40 × 13,5	13,5

Tine

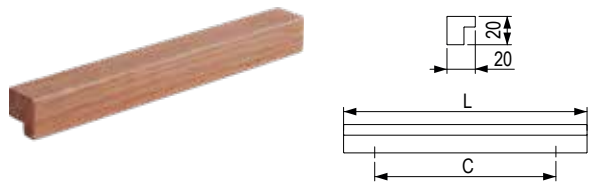

lakkozott tölgy	natúr tölgy	furattávolság C (mm)	hossz L (mm)
497682	497685	128	172
497683	497686	320	365
497684	497687	960	1000

Chico

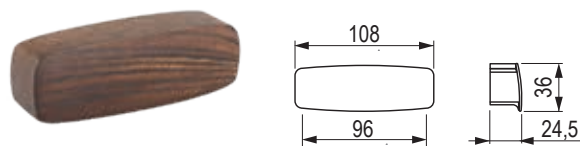

lakkozott dió
543770

Wave

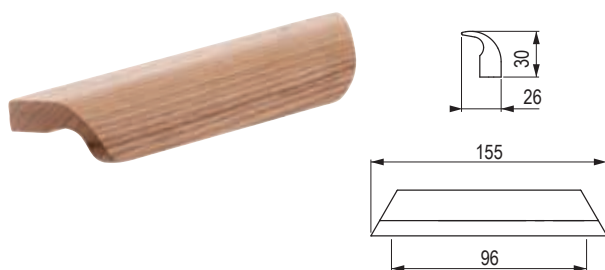

natúr tölgy	lakkozott tölgy
404347	404348

Moku

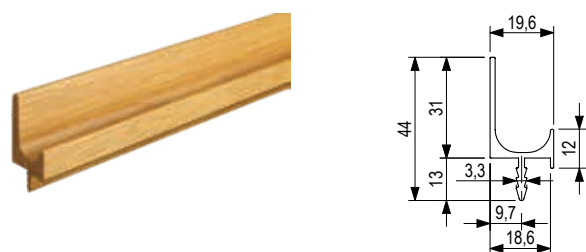

natúr tölgy	lakkozott tölgy	hossz L (mm)
547185	547184	2400

Ames

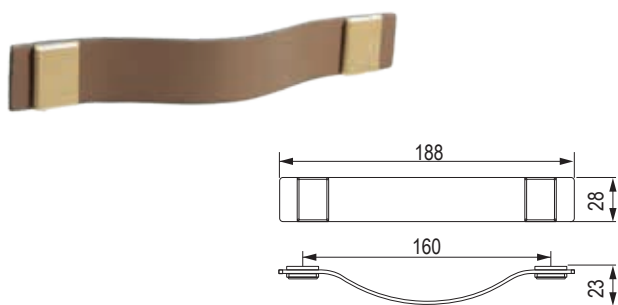

barna
547156

Ames

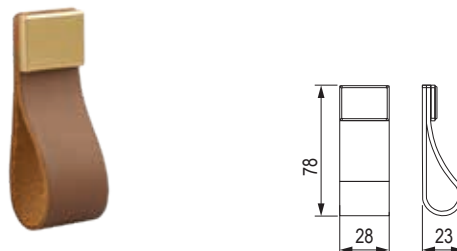

barna
547157

Square

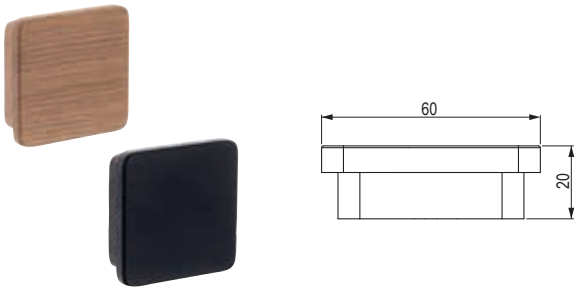

natúr tölgy	lakkozott tölgy	bükk fekete
404337	404338	404341

Hole

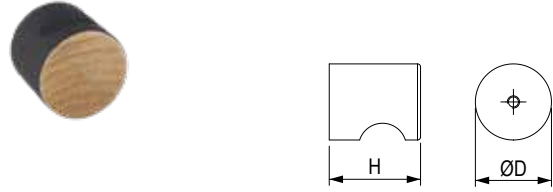

	átmérő D (mm)	magasság H (mm)
497674	25	30
497675	40	35

Taper



natúr tölgy	lakkozott tölgy	fekete	natúr bükk	lakkozott bükk	fehér
404331	404332	404335	404333	404334	404336

Jura



lakkozott tölgy	lakkozott fenyő	lakkozott bükk
09413	09414	09415







Jacek



lakkozott tölgy	lakkozott fenyő	lakkozott bükk	natúr bükk	natúr fenyő
09401	09402	09403	158699	158698

Adam



					
lakkozott tölgy	lakkozott fenyő	lakkozott bükk	natúr bükk	lakkozott éger	natúr fenyő
09409	09410	09411	158704	09412	158703

Bala

Festett fa



		
sötétkék	lila	olíva
212674	09491	09493

Sola

Festett fa



	
világoskék	sárga
158717	158723

Cute

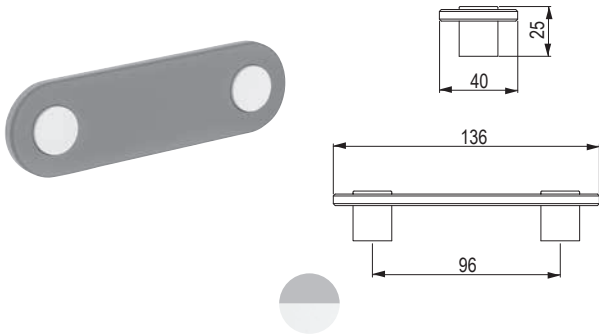

szürke/fehér

405137

Cute



szürke/fehér

405148

P431



fehér

265483

P439



fehér

265486

Spaccata



barna kötél

351879

Spaccata

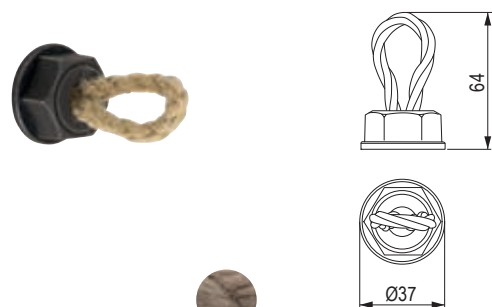

barna kötél

382066



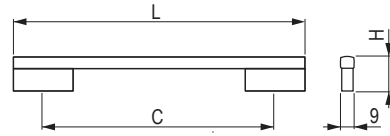

Cana

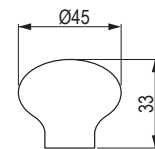

						
rózsaszín	zöld	fehér	világoskék	furattávolság C (mm)	hossz L (mm)	magasság H (mm)
303199	303203	303211	303207	128	152	30
303200	303204	303212	303208	160	200	30

Funga



			
rózsaszín	zöld	fehér	világoskék
303233	303234	303236	303235

Palla

Puha műanyag

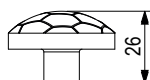
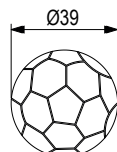

motívum
198702

Bottone

Edzett műanyag

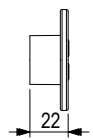
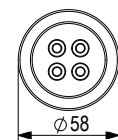

fehér
351883



kék
351884



rózsaszín
351885

Into

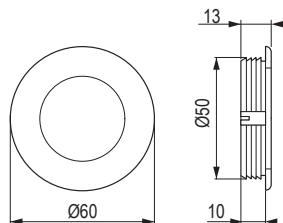

fehér

405152



fekete

405154

Large

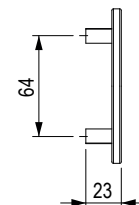
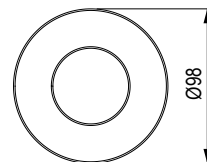

fehér

405157



szürke

405158



rózsaszín

405160



Fogasok

Filip [Stainless steel]

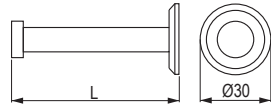

csiszolt nemesacél

372855

352456

hossz
hossz L (mm)

52

72

Element [Stainless steel]

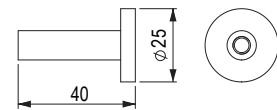

csiszolt nemesacél

484696



króm fényes

484697



csiszolt arany

484700



csiszolt fekete

484698

Balo [Zamac]

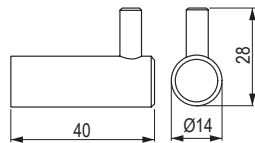

matt fekete

398940

Rudi [Zamac]

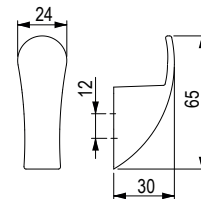

nikkel csiszolt

483279



csiszolt sötét arany

491190



matt fekete

483278

Troy [Zamac]

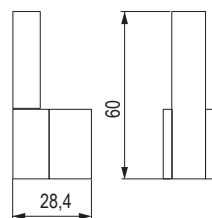

champagne bronze

547177



steel grey

547178



csiszolt fekete

547176

Boise [Zamac]

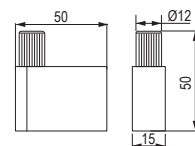

csiszolt sötét arany

547181



matt fekete

547180

Doris [Zn]

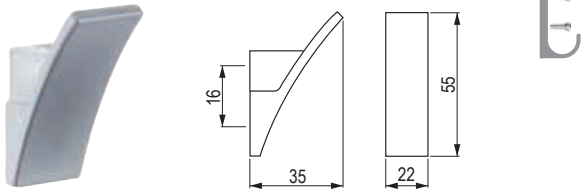

- 
króm matt
- 
nikkel csiszolt
- 
matt fekete

204687 **204688** **544822**

Dyan [Zamac]

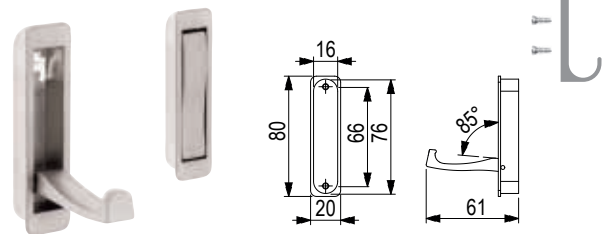

- 
matt nikkel
- 
króm matt

231588 **231589**

Rini [Zamac]

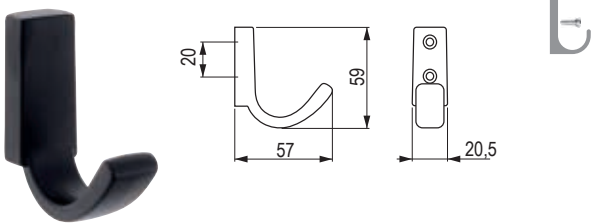

- 
matt fekete

505995

Rini XL [Zamac]

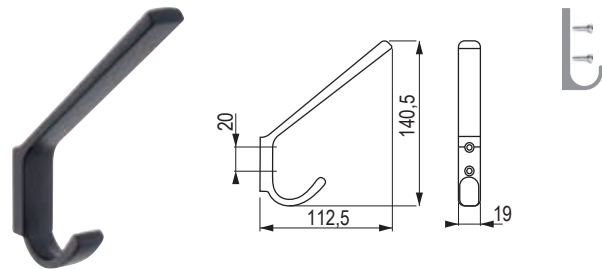

- 
matt fekete

505996

Peri [Zamac]

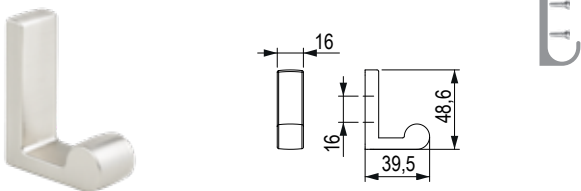



- 
nikkel csiszolt
- 
matt fekete

494191 **494190**

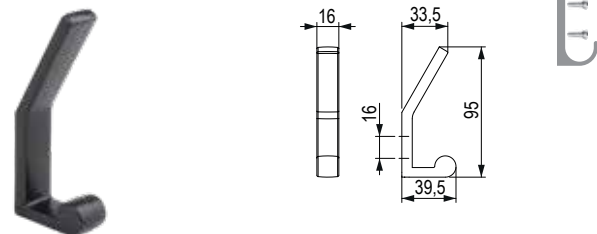
Peri XL [Zamac]



- 
nikkel csiszolt
- 
matt fekete

494193 **494192**

Fogasok

Pera [Zamac]

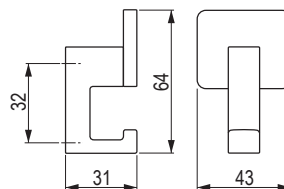

eloxált alumínium

77812



nikkel csiszolt

77813



sötét arany matt

399803



matt fekete

356378

Kara S [Zamac]

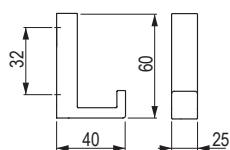

nikkel csiszolt

284988



króm fényes

284991



matt fekete

355732



fehér fényes

355729

Kara M [Zamac]

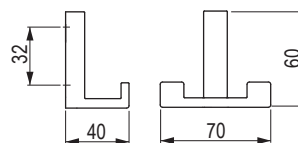

nikkel csiszolt

284989



króm fényes

284992



matt fekete

355731



fehér fényes

355728

Kara L [Zamac]

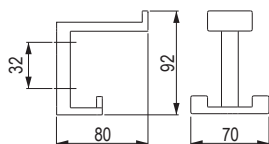

nikkel csiszolt

284990



króm fényes

284993



matt fekete

355730



fehér fényes

355727

Marell [Zamac]

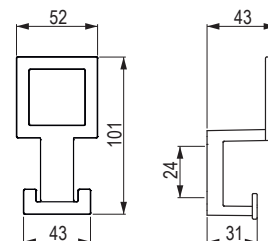

nikkel csiszolt

398005



matt fekete

398004

Gant [Zn]

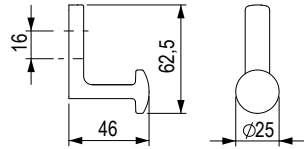

nikkel csiszolt

483282



matt fekete

483280

Gant XL [Zamac]

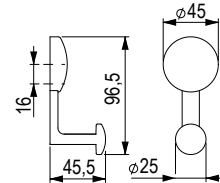

nikkel csiszolt

483285



matt fekete

483284

Dax [Zamac]

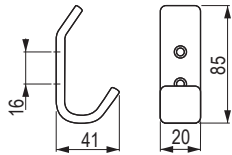

króm matt

157327



matt nikkel

157328

Iwo [Zamac]

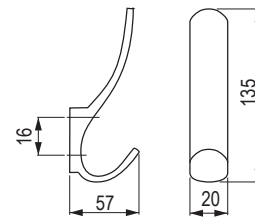

matt nikkel

289683



króm matt

289684

Ener [Zamac]

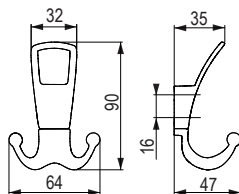

nikkel csiszolt

483276



matt fekete

483275

Ener XL [Zamac]

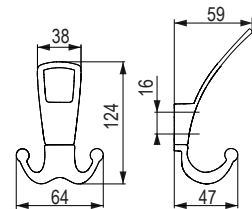

nikkel csiszolt

483274



matt fekete

483273

Fogasok

Cid [Zamac]

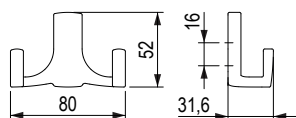

nikkel csiszolt

494171



matt fekete

494170

Cid XL [Zamac]

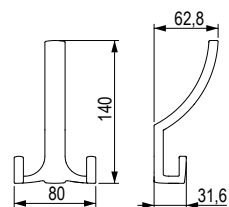

nikkel csiszolt

494173



matt fekete

494172

Marcel [Zamac]

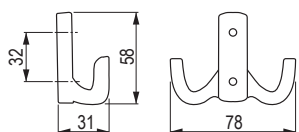

króm fényes

290153



króm matt

290154



matt nikkel

290155

Marcel XL [Zamac]

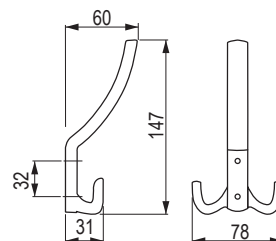

króm fényes

290150



króm matt

290151



matt nikkel

290152

Lugo [Zamac]

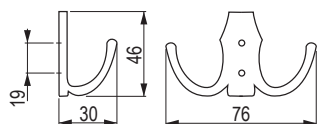

matt nikkel

35591



króm matt

35592



króm fényes

35593



arany fényes

35594



matt fekete

35595

Lugo XL [Zamac]

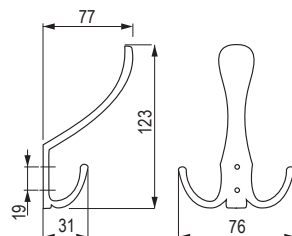

matt nikkel

35581



króm matt

35582



króm fényes

35583



arany fényes

35584



matt fekete

35585

Muso [Zn]

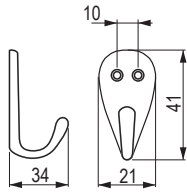

króm matt

157333



matt nikkel

157334



króm fényes

157335



matt fekete

544823

Lerico [Zn]

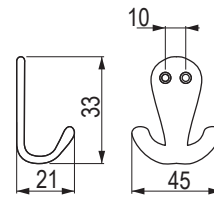

króm matt

157330



matt nikkel

157331



króm fényes

157332



matt fekete

544824

Livorno [Zamac]

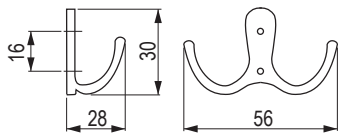

matt nikkel

35611



króm matt

35612



króm fényes

35613



matt fekete

35615

Rokos [Zamac]

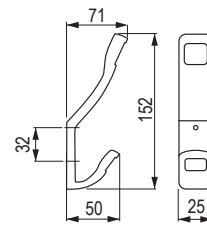

matt nikkel

289681



króm matt

289682

Darec [Zamac]

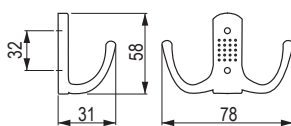

króm fényes

289679



króm matt

289680

Darec XL [Zamac]

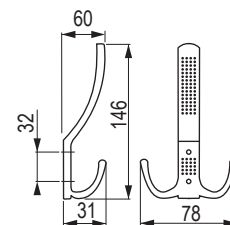

króm fényes

289677



króm matt

289678

Murero [Zn]

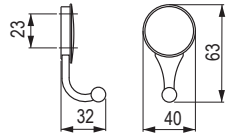

óarany

157317

Murero XL [Zn]

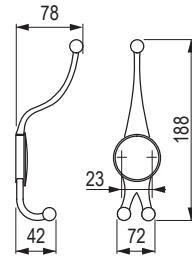

óarany

157319

Rubico [Zn]

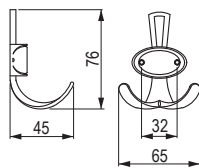

ófekete

157309



óarany

157310

Rubico XL [Zn]

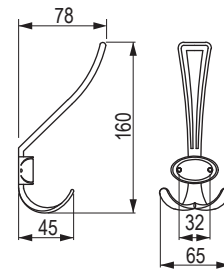

ófekete

157311



óarany

157312

Orio [Zamac]

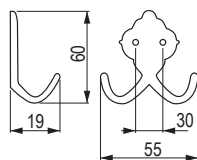

óarany

36769

Orio XL [Zamac]

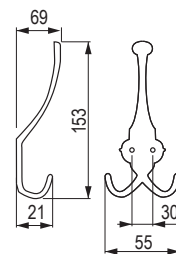

óarany

36768

Balo XL [Zamac]

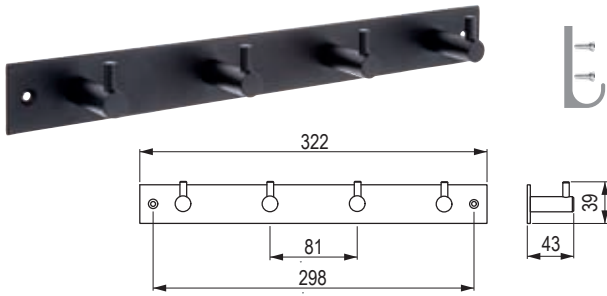

matt fekete

398939

Twist [Zamac]

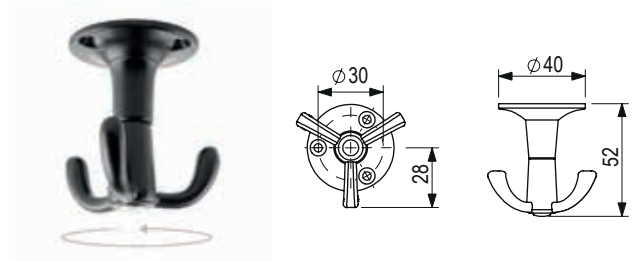

króm matt

414103

matt fekete

414102

Xin

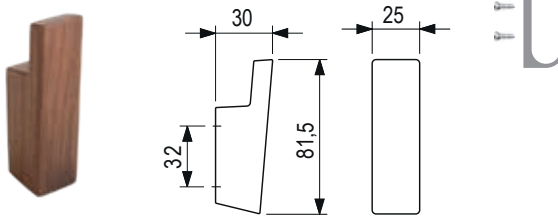

natúr tölgy

500437

lakkozott tölgy

500438

lakkozott dió

500439

Extendo XL [Zamac]

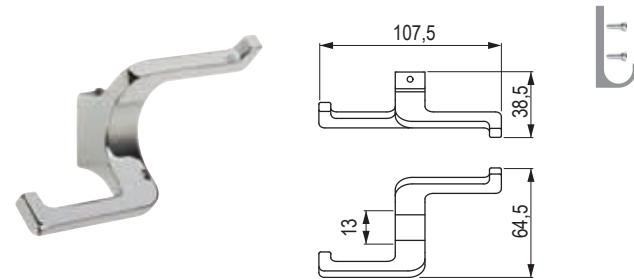

króm matt

283968

nikkel csiszolt

283969

fogantyúk, bútorgombok és fogasok

Vitruvio [Zamac]

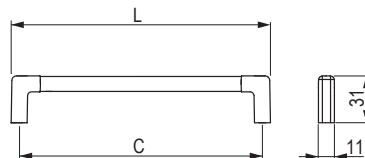
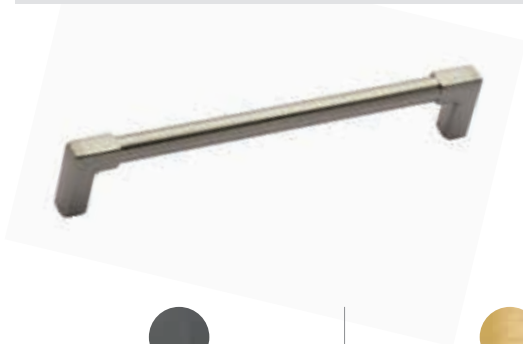

				
	antracit	arany matt	furattávolság C (mm)	hossz L (mm)
	405059	405061	160	170,6
	405060	405062	320	330,6

Lama [Zamac]

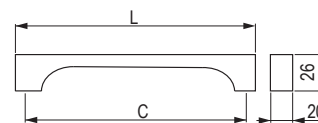

					
	arany matt	barna matt	sötét nikkal	furattávolság C (mm)	hossz L (mm)
	356243	356245	356247	160	170
	356242	356244	x	320	330

Tonda [Zamac]

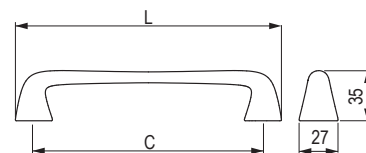

				
	fekete silk touch	szürke silk touch	furattávolság C (mm)	hossz L (mm)
	405046	405050	160	184,4
	405047	405051	320	344,4

Torus [Zamac]

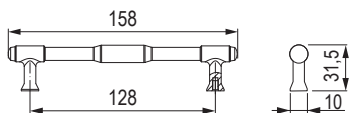

arany matt

541307



matt fekete

541309

Torus [Zamac]

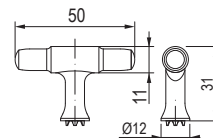

arany matt

541308



matt fekete

541310

Riva [Zamac]

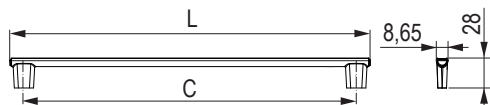

titanium

541315



matt fekete

541311

furattávolság
C (mm)

160

hossz
L (mm)

177

541316

541312

320

337

541318

541314

1088

1110

Riva [Zamac]

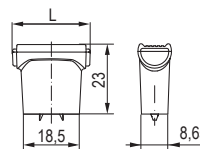

titanium

541317



matt fekete

541313

hossz L (mm)

26

fogantyúk, bútorgombok és fogasok

Linea [Zamac]

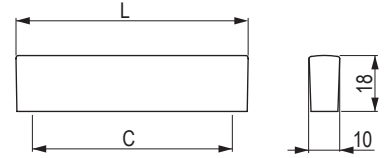

fekete silk touch

furattávolság
C (mm)hossz
L (mm)**405070**

32/64

76

405072

224/256

268

Brera [Zamac]

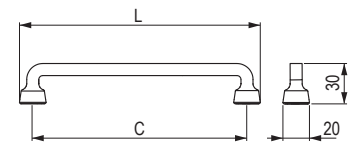

óbronz



matt fekete

arany
csiszoltfurattávolság
C (mm)hossz
L (mm)**356226****356229****405054**

96

116

356225**356228****405055**

160

180

356224**356227****405056**

320

340

Defense [Zamac]

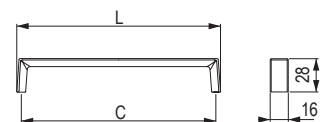

- a színárnyalatok eltérhetnek egymástól



óarany



matt fekete

furattávolság
C (mm)hossz
L (mm)**356233****356235**

160

167

356232**356234**

320

327

Art Decó [Zamac]

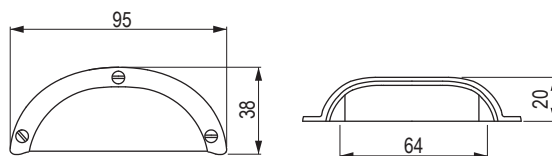

- a színárnyalatok eltérhetnek egymástól



rozsdahatás
356270



blue washed
356271

Viaggio [Zamac]

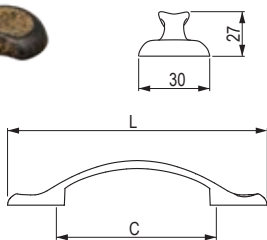

- a színárnyalatok eltérhetnek egymástól



Washed Stone
356261
356260



rozsdahatás
356264
356263

furattávolság
C (mm)
96
128

hossz
L (mm)
156
187

Viaggio [Zamac]

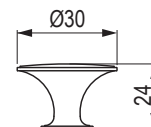

- a színárnyalatok eltérhetnek egymástól



Washed Stone
356262



rozsdahatás
356265

Sirius [Zamac]

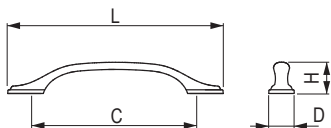

- a színárnyalatok eltérhetnek egymástól



rozsdahatás
356254
356253
356252



ócinke
284267
284268
284269

furattávolság
C (mm)
96
128
160

hossz
L (mm)
142
177
210

szélesség
D (mm)
21
22
25

magasság
H (mm)
28
29
30

Columnae [Zamac]

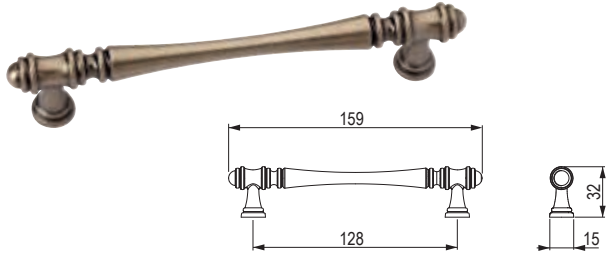

bronz
405063



óczink
405064



óréz sötét
405065

Columnae [Zamac]

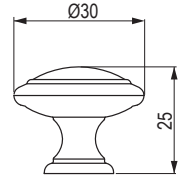

bronz
405066



óczink
405067



óréz sötét
405068

Macis [Zamac]

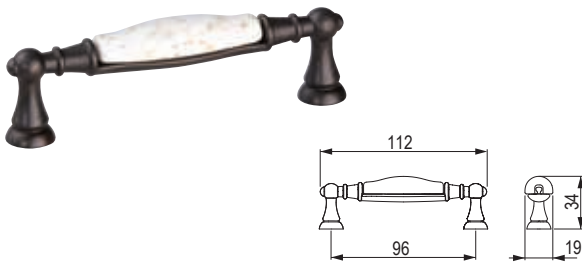

óréz sötét/fehér porcelán
284279

Macis [Zamac]

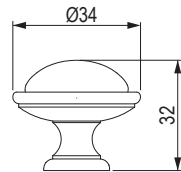

óréz sötét/fehér porcelán
284280

Augusto [Zamac]

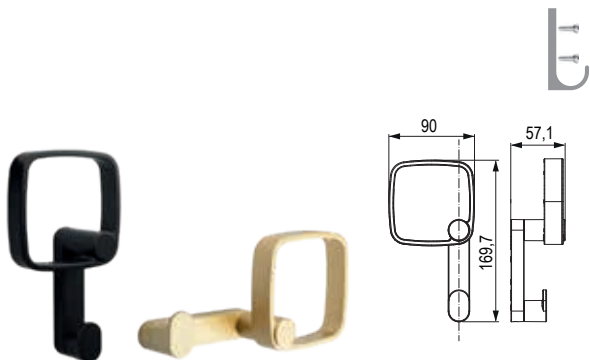

sötét arany matt

541305



matt fekete

541304

Tiberio [Zamac]



matt fekete

541306

Smarty [Zamac]

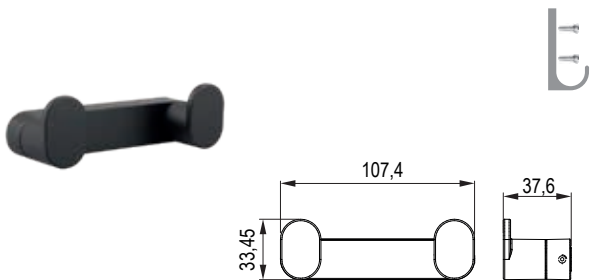

matt fekete

541301

Jonathan [Zamac]

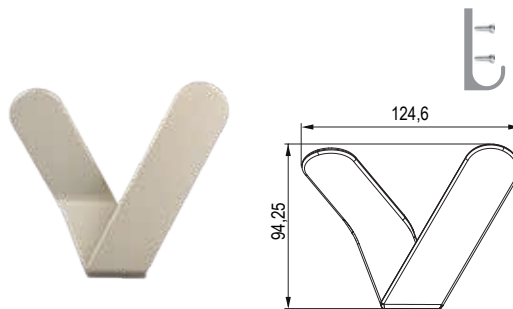

titanium

541302



matt fekete

541303

Aramis S [Zamac]

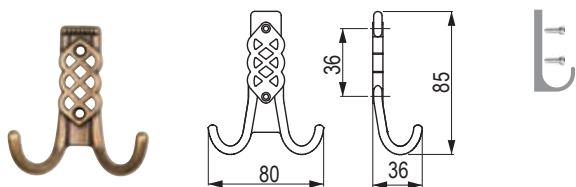

bronz

284271

Aramis M [Zamac]

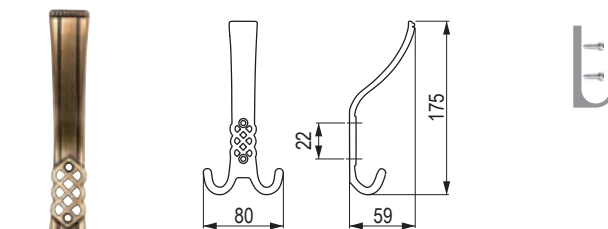

bronz

284273

fogantyúk, bútorgombok és fogasok

Florida profilok

- Lehetőség különböző kombinációkra kész profilból és 3 m-es profilból méretre vágva.
- A rövidített profil 3 féle végzáróval zárható le.
- A profil függőlegesen és vízszintesen is használható.
- Profil kombináció pántos ajtókhöz és tolóajtókhöz is egyaránt.

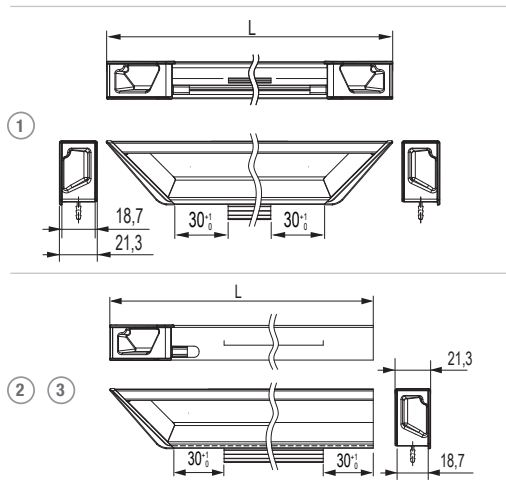
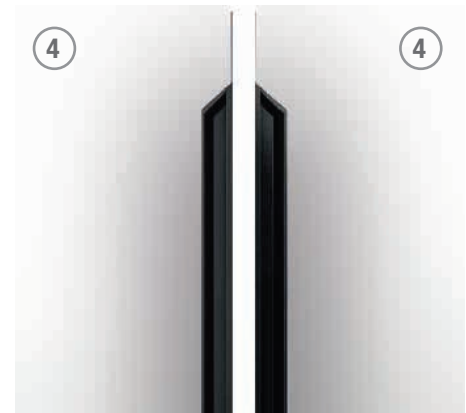

		hossz L (mm)	változat	ajtó vastagsága (mm)	magasság (mm)
1	541319	380	középső	18	36
2	541323	200	bal	18	36
	541324	380	bal	18	36
3	541320	200	jobb	18	36
	541321	380	jobb	18	36
4	541325	1088	bal	18	36
	541322	1088	jobb	18	36



Florida profil

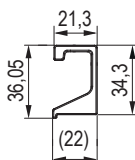

	hossz L (mm)	ajtó vastagsága (mm)	magasság (mm)
matt fekete	3000	18	36
541326			

Végzárók a Florida profilhoz

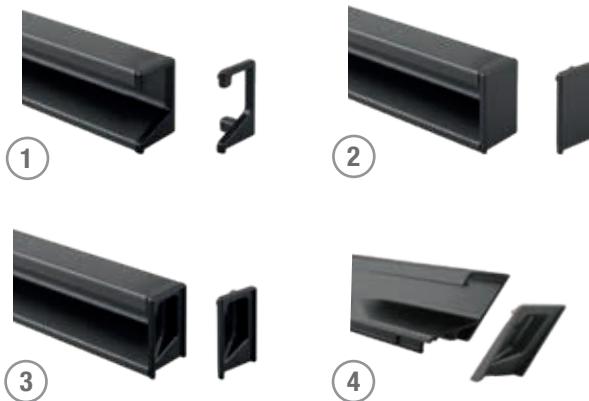

	változat
1 541327	nyitott végzáró J+B
2 541328	zárt végzáró J+B
2 541329	középső végzáró J+B
4 550784	középső egyenes végzáró



fogantyúk és bútorgombok

Anzio

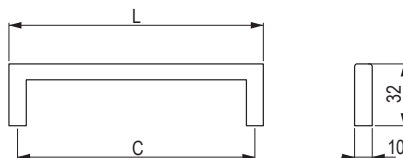

kód	Hettich kód	felület	furattávolság C (mm)	hossz L (mm)
133350	1160018	csiszolt nemesacél	128	138
135134	1160020	csiszolt nemesacél	224	234
146741	1160023	csiszolt nemesacél	288	298
318716	9204177	csiszolt nemesacél	320	330
133349	1160022	csiszolt nemesacél	352	362
146742	1160023	csiszolt nemesacél	480	490

Bermeo

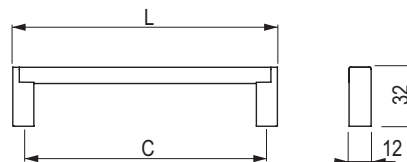

kód	Hettich kód	felület	furattávolság C (mm)	hossz L (mm)
395157	9208083	matt fekete/nemesacél imitáció	160	173
395156	9208087	matt fekete/nemesacél imitáció	288	301

Intra

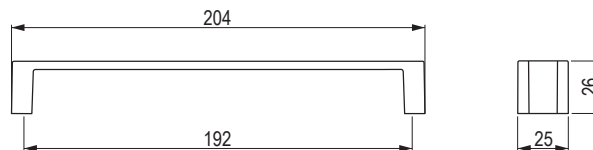

kód	Hettich kód	felület
153731	9105735	nemesacél imitáció/króm fényes
134824	9105737	króm matt/króm fényes

Salacia

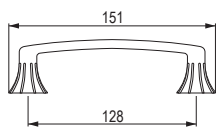
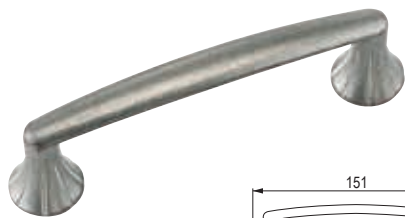

kód	Hettich kód	felület
135768	9112591	cink

Baldone

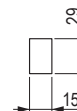
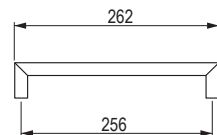
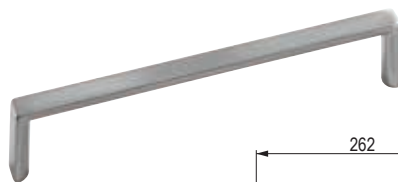

kód	Hettich kód	felület
135846	9995485	nemesacél imitáció

Chalcis

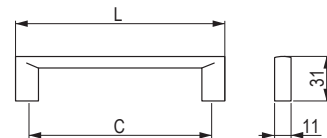

kód	Hettich kód	felület	furattávolság C (mm)	hossz L (mm)
161149	9113183	nemesacél imitáció	128	147
154385	9113182	nemesacél imitáció	288	301

Naila

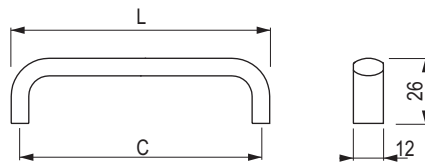

kód	Hettich kód	felület	furattávolság C (mm)	hossz L (mm)
409634	9266078	matt fekete	96	103
409635	9266079	matt fekete	128	135
409636	9266080	matt fekete	160	167
409637	9266091	matt fekete	192	199
409638	9266092	matt fekete	256	263
409640	9266094	matt fekete	320	327

Catana

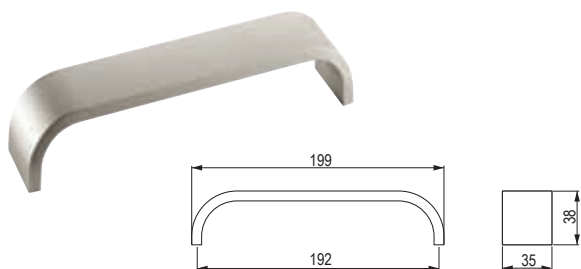

kód	Hettich kód	felület
106317	115080	nemesacél imitáció

Vantania

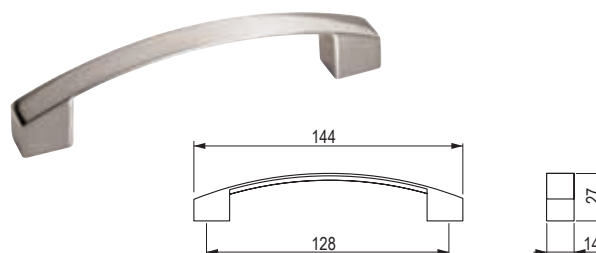

kód	Hettich kód	felület
134885	1170158	nemesacél imitáció
153735	9113211	króm fényes

Salona

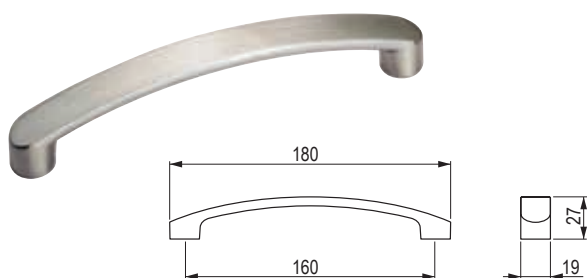

kód	Hettich kód	felület
141597	1170155	nemesacél imitáció

Egara

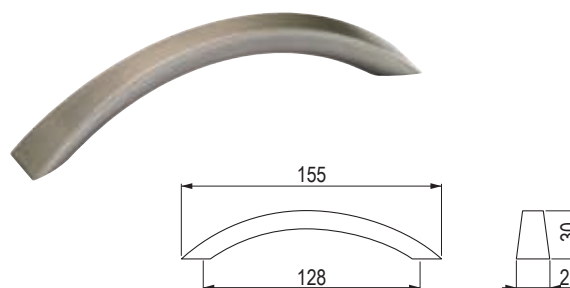

kód	Hettich kód	felület
106184	9071719	óarany
106258	9071720	csiszolt cink

Balmo

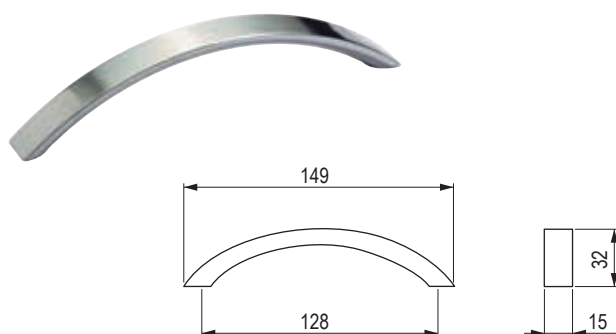

kód	Hettich kód	felület
107814	43472	nemesacél imitáció

Genoa

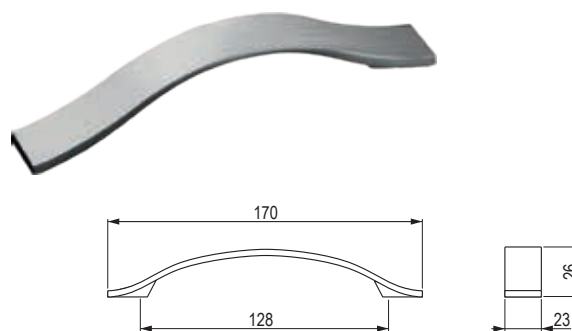

kód	Hettich kód	felület
106675	9065612	nemesacél imitáció

Fermo

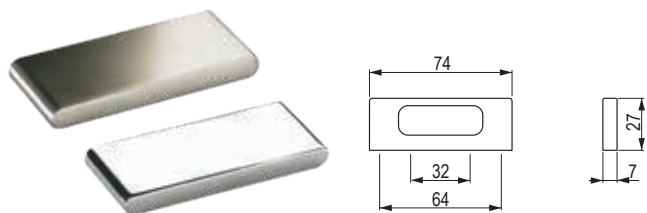

kód	Hettich kód	felület
107413	115020	króm fényes
106987	115019	nemesacél imitáció

Messana

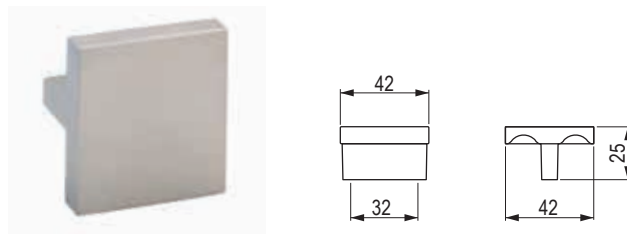

kód	Hettich kód	felület
107020	115156	nemesacél imitáció

Coria

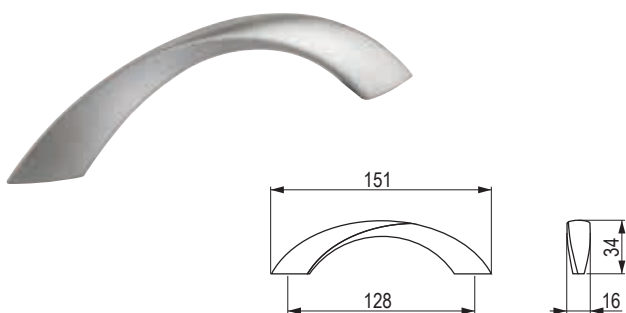

kód	Hettich kód	felület
154567	9112597	króm matt

Haida

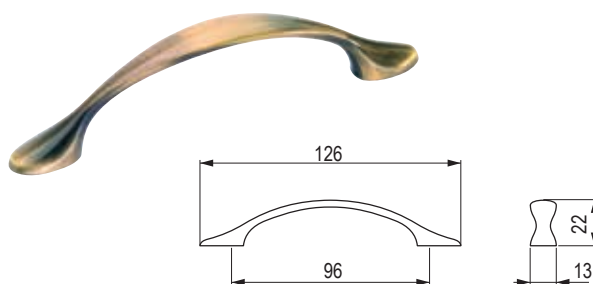

kód	Hettich kód	felület
156856	9113227	óarany

Monacum

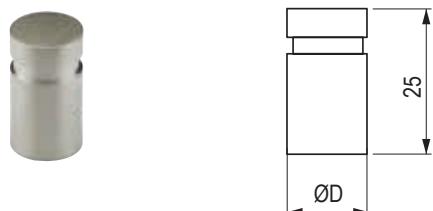

kód	Hettich kód	felület	átmérő D (mm)
106762	9070957	csiszolt nemesacél	10
106562	9070958	csiszolt nemesacél	14

Almus

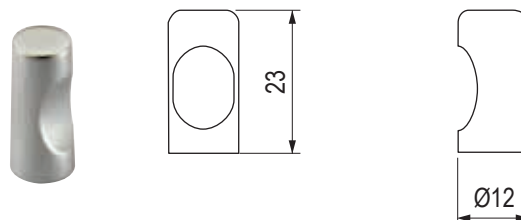

kód	Hettich kód	felület
106827	9112583	króm fényes
105387	9112588	matt nikkel
153736	9114036	nemesacél imitáció

fém fogantyúk

Gela

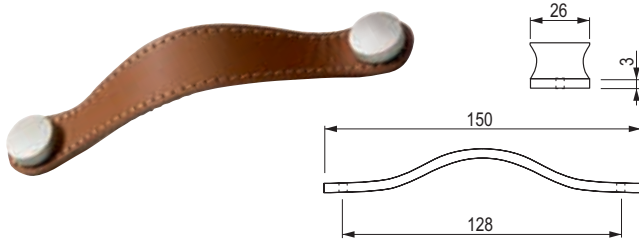

kód	Hettich kód	felület
182316	9113645	világosbarna
131687	9113646	sötétbarna
187687	9113647	fekete

Galati

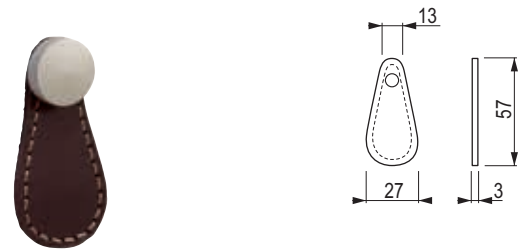

kód	Hettich kód	felület
409643	9113645	világosbarna
409644	9113646	sötétbarna

Rögzítő elemek a Gela és Galati fogantyúkhöz



kód	Hettich kód	felület
376385	9113651	króm matt
187690	9113653	matt nikkél
187691	9113654	óbronz

Aboa

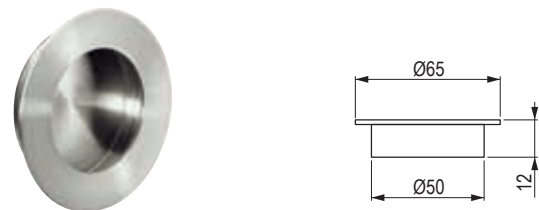

kód	Hettich kód	felület
106763	9070138	csiszolt nemesacél

Empoli

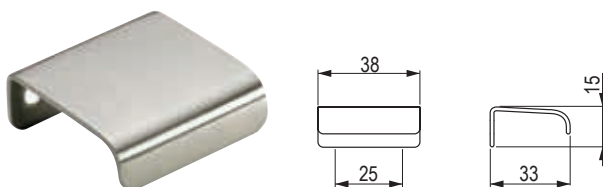

kód	Hettich kód	felület
131685	9995541	króm fényes
133474	9995540	króm matt
142100	9995542	nemesacél imitáció

Narni

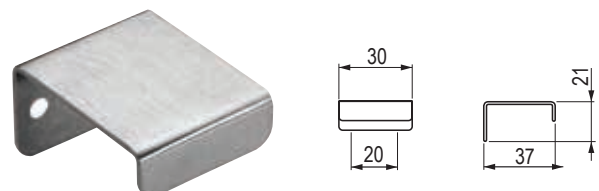

kód	Hettich kód	felület
134538	9995574	csiszolt nemesacél

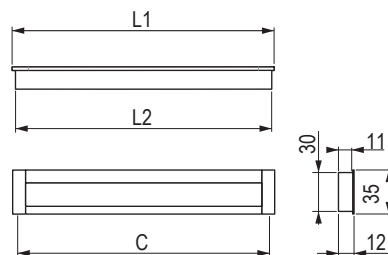
Nidum

kód	Hettich kód	felület	furattávolság C (mm)	hossz L1 hossz (mm)	hossz L2 hossz (mm)
106761	9071060	eloxált alumínium	96	111	107
105388	9071071	eloxált alumínium	128	143	139
107319	9071073	eloxált alumínium	160	175	171
106090	9071075	eloxált alumínium	192	207	203

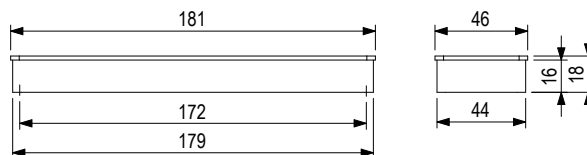
Touch - in

kód	Hettich kód	felület
105901	9086687	nemesacél imitáció

Touch - in

kód	Hettich kód	leírás	felület
130326	9086695	takarósapka	nem lakkozott műanyag
127861	9086696	takarósapka	nemesacél imitáció
106193	9086691	fogantyú	nemesacél imitáció

- felületkezelés nélküli takaró (ABS műanyag) festhető
- furnér vagy más hasonló anyag felragasztására alkalmas felületkezelte takaró

A harmonika ajtókhöz alkalmas fogantyúk rögzítéséhez szükséges adapter

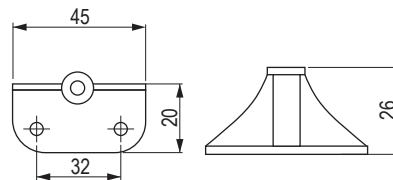

króm

289675

szatén nikkell

289676

Műanyag alátét fogantyúhoz üvegre



gumi alátét fogantyúhoz

08002

- szakszerű szereléshez használjon 2 db alátétet egy csavarhoz
- a fém nem érintkezhet közvetlenül az üveggel
- átlátszó, 4mm átmérőjű csavaroknak

BlueJig jelölősablon fogantyúkhöz

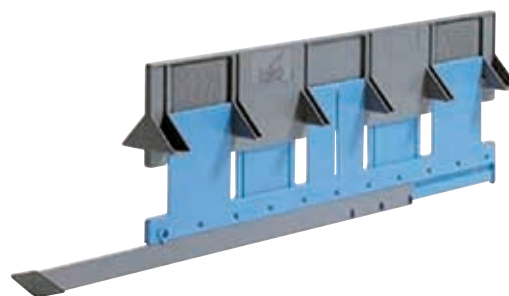

jelölési sablonok

104215

- univerzális sablon BLUEJIG kéttengelyes beállítással a furatok helyzetének gyors és pontos megjelöléséhez
- 32 - 320 (mm) furattávolságú fogantyúkhöz készültek
- a fiók előlapjának oldalsó élétől a fogantyú első szerelési nyílása 10 - 334 (mm) távolságban lehet
- az előlap felső élétől, ill. az előlap alsó élétől a fogantyúig 20 - 65 (mm) a távolság

Tulip állítható fúró sablon fogantyúkhöz

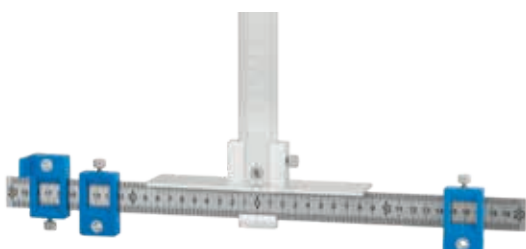

sablon

495129

- Tulip sablon a fogantyúk nyílásainak megjelölésére
- két tengely (függőleges és vízszintes) szerinti beállítás
- 16 mm és 480 mm közötti fogantyúkhöz
- anyag: alumínium, műanyag

TULIP

Fogantyú, amely felvirágzik minden enteriőrben

